





HORNET™

FLYING MODEL #2030
ROCKET KIT

ESTES INDUSTRIES
1295 H Street
Penrose, CO 81240

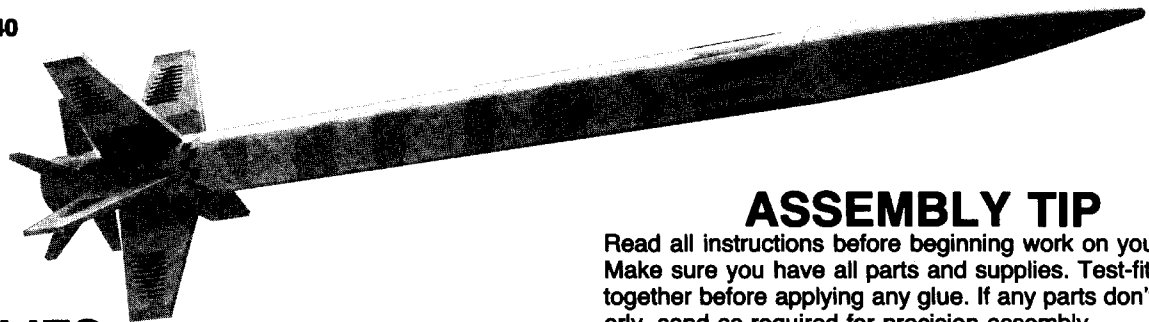

PARTS AND SUPPLIES

Locate the parts shown below and lay them out on the table in front of you.

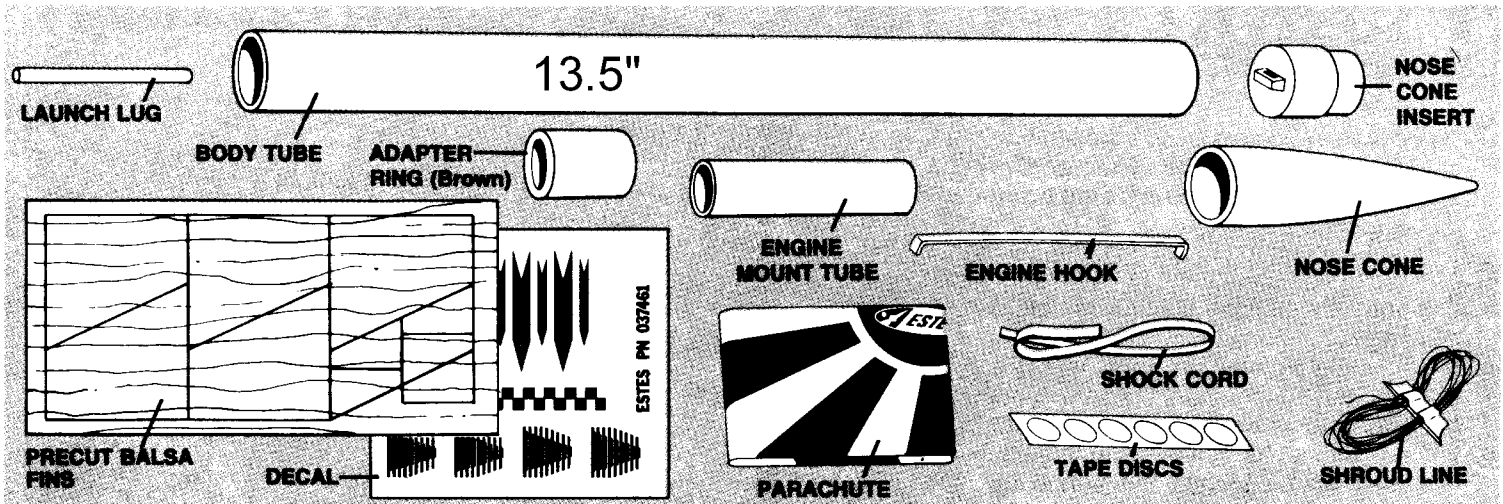

ASSEMBLY TIP

Read all instructions before beginning work on your model. Make sure you have all parts and supplies. Test-fit all parts together before applying any glue. If any parts don't fit properly, sand as required for precision assembly.

In addition to the parts included in the kit you will also need:

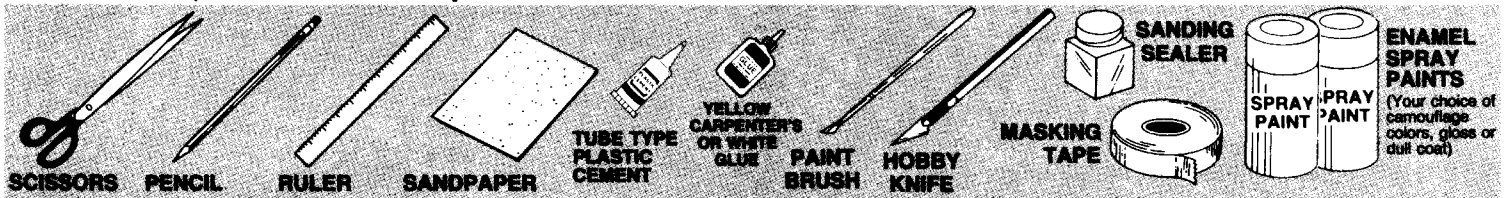

ROCKET ASSEMBLY

- Mark engine mount tube 1 inch and 2 1/2 inches from one end and then cut 1/8 inch long slit at 2 1/2 inch mark.
 - Insert one end of engine hook into slit.
 - Sand inside edges of adapter ring.
 - Slide adapter ring onto engine mount tube stopping at the 1 inch mark. Glue both ends of ring to tube. Allow glue to dry.

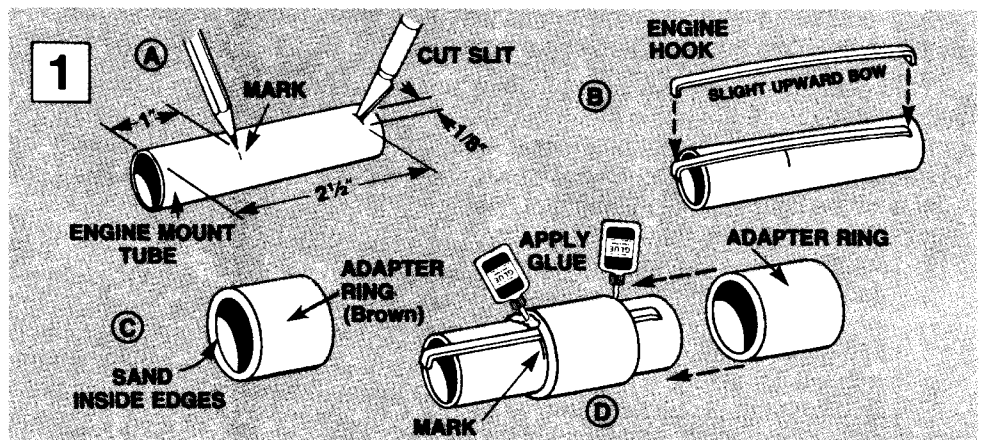

- Fine sand balsa die-cut sheet. Carefully remove fins by freeing edges with sharp knife.
 - Stack large fins together. Sand all edges smooth.
 - Stack small fins together. Sand all edges smooth.

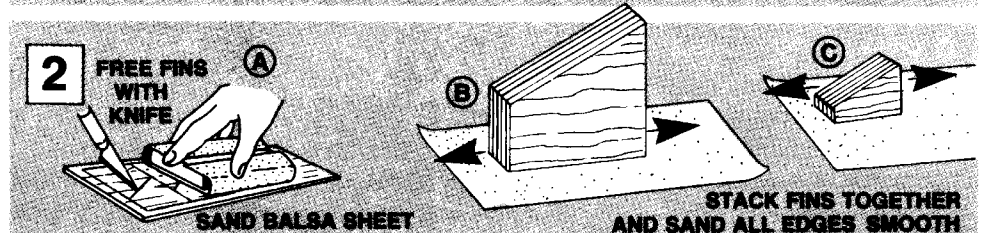

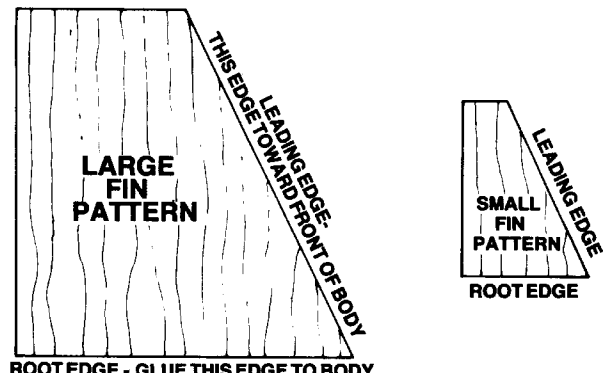
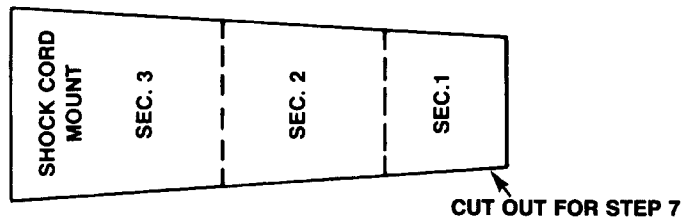
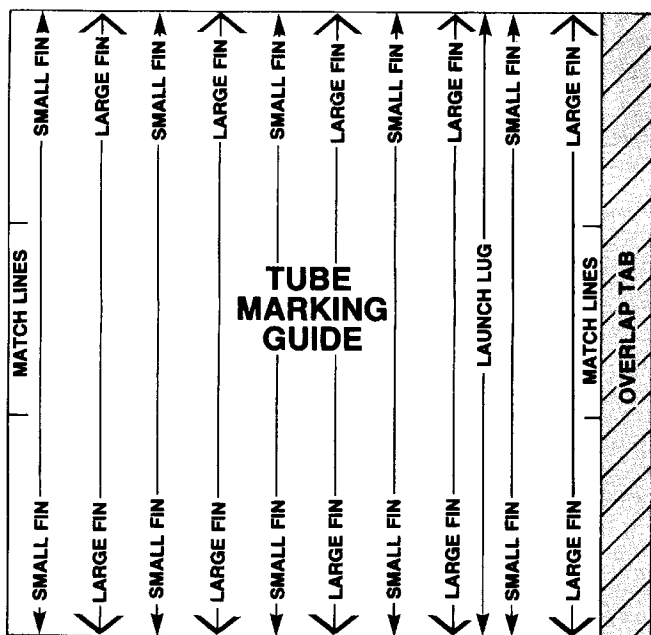

Use these as fin patterns

3. Apply a line of glue around inside of one end of body tube as shown. Push engine mount into tube until tube ends are even. Allow glue to dry.

4.

A. Cut out tube marking guide from top of this page.

B. Wrap guide around the tube with the overlap tab underneath. Apply tape. Mark tube at arrows. Identify the small fin lines with an "S". Identify the large fin lines with an "L". Identify the launch lug line with an "LL". Remove guide.

C. Draw straight lines connecting each pair of marks. Extend the launch lug line 7 inches from rear of tube.

5. Mark the tube for the small fins on every small fin line at 1/4 inch from rear of tube (5 total). Mark the tube for the large fins on every large fin line at 1 1/4 inch from rear of tube (5 total). Mark the tube on the launch lug line at 3 5/8 inches from rear of tube.

6.

A. Apply glue to root edge of a large fin. Glue large fin next to alignment line with rear of the fin on the 1 1/4 inch mark. Repeat for the other large fins. Apply each fin on same side of its fin alignment line. Let each fin dry several minutes before applying the next one.

B. Glue small fins next to alignment lines with rear of fin on the 1/4 inch marks. Follow the same procedure used to attach large fins. Looking at the rocket from the rear, the fins should be in the positions shown.

C. Glue launch lug on launch lug line at the 3 5/8 inch mark as shown. Launch lug must be straight on body tube.

D. Support the rocket horizontally until glue dries.

3 GLUE ENGINE MOUNT INTO BODY TUBE

4 TUBE MARKING GUIDE

REAR, MARK TUBE AT ARROWS, REMOVE MARKING GUIDE, CONNECT MARKS WITH PENCIL LINES, DOOR FRAME, EXTEND LAUNCH LUG LINE 7"

5 MARK THE TUBE FOR REAR OF FINS

1 1/4", 1/4", 3 5/8", LL

6

A GLUE LARGE FINS, B GLUE SMALL FINS, C GLUE LAUNCH LUG

1 1/4" MARK, ROOT EDGE, LEADING EDGE, 3 5/8" MARK

FINS MUST BE ATTACHED CORRECTLY FOR STABLE FLIGHT!

RIGHT, WRONG

7.

- A. Cut shock cord mount from page 2.
- B. Crease on dotted lines by folding. Spread glue on section 2 and lay end of shock cord into glue at a slight diagonal as shown. Fold section 1 forward. Apply glue to section 3. Fold forward again. Clamp firmly with your fingers until glue sets.
- C. Apply glue to the shock cord mount. With the shock cord mount positioned on the end of your finger or a pencil, gently position the mount into the front of body tube. Set back far enough from the front edge of the tube to allow the nose cone to fit into place (1½ inches). Press shock cord mount into position. Smear a film of glue over the mount and surrounding area in the body tube to insure a good bond and a smooth surface.

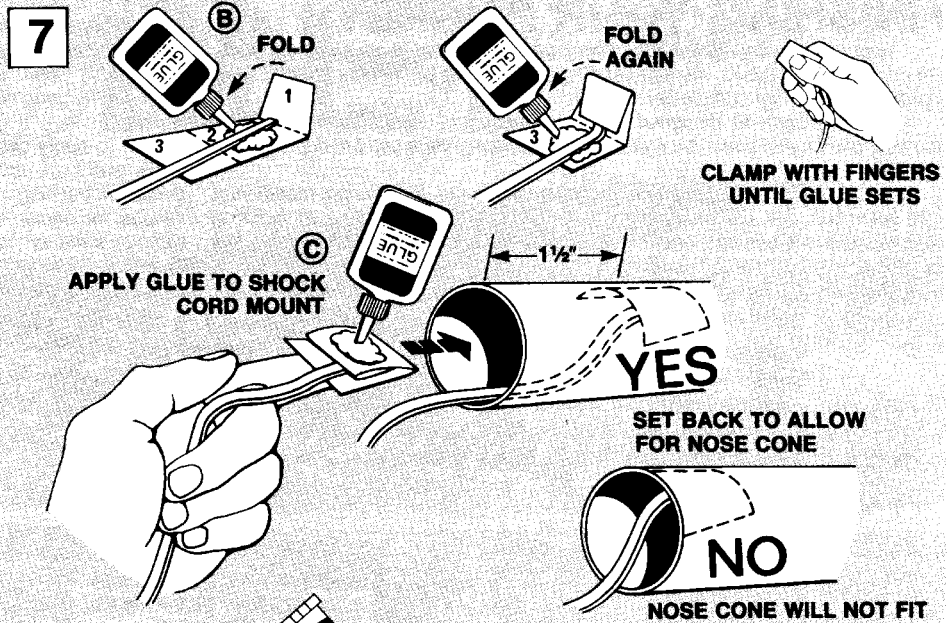

8. Apply plastic cement to inside edge of nose cone, and then install nose cone insert as shown.



9. Apply a glue reinforcement to each side of each fin/body tube joint and to each side of the launch lug. Smooth them out with your finger.

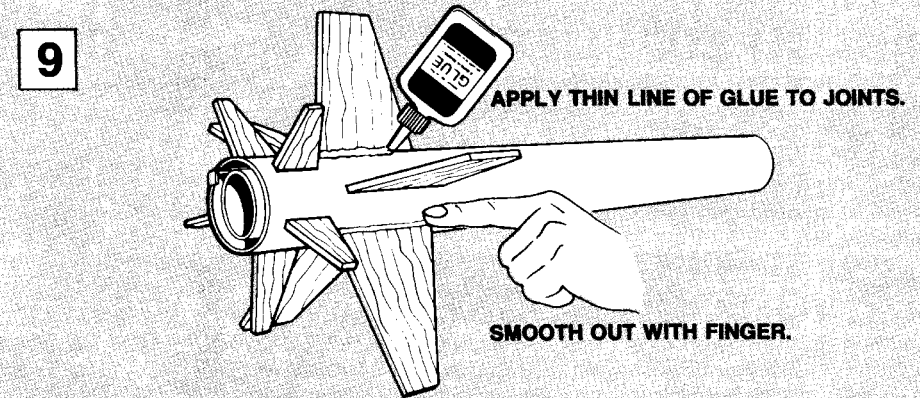

10.

- A. Cut out parachute on edge lines.
- B. Cut three 23 inch lengths of shroud line.
- C. Form small loops with shroud line ends and press onto sticky sides of tape discs.
- D. Attach tape discs with the line ends to top of parachute as shown.
- E. Firmly press tape discs into place until both tape discs and parachute material are molded around shroud line loops.
- F. Pass shroud line loops through eyelet on nose cone. Pass parachute through loop ends and pull lines against the nose cone.
- G. Tie free end of shock cord to nose cone eyelet using a double knot.

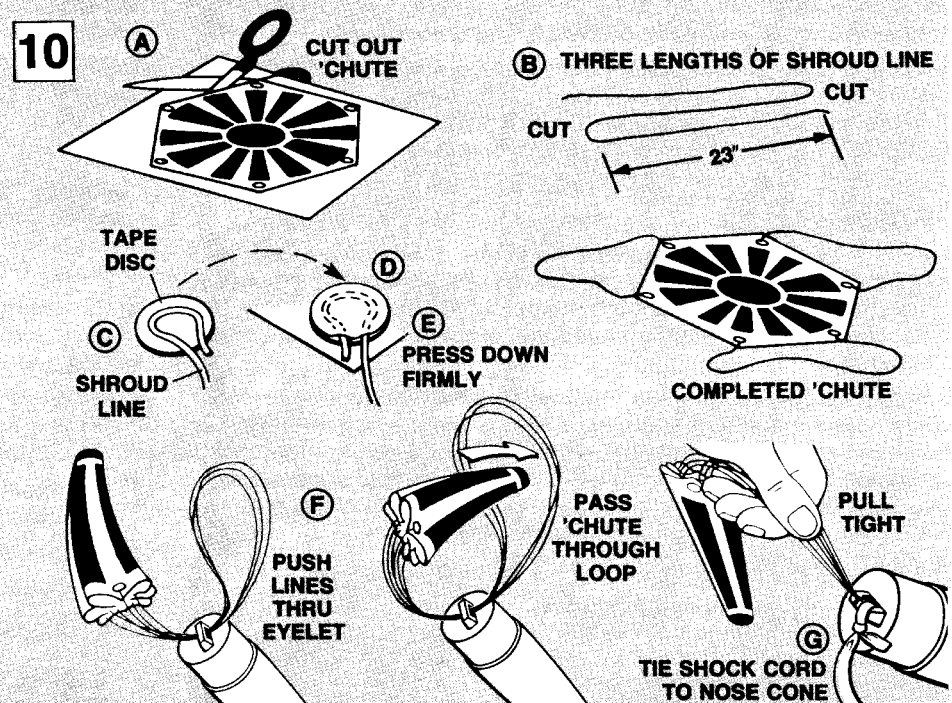

FINISHING YOUR ROCKET

Let all glue dry completely. Apply sanding sealer to all balsa surfaces. Let dry and sand lightly. Repeat sanding and sealing until balsa grain is filled and smooth. Let dry completely.

This rocket was designed to be painted aerial camouflage colors, but you may paint it any color you wish. Military aircraft photos can provide a wealth of ideas.

Applying a camouflage finish is relatively simple. Paint entire model your light color first. We used aircraft gray. Apply strips of jaggedly torn masking tape to achieve a realistic, uneven separation for the second, darker color. We

used Wedgewood blue. Spray paint the second color. Let paint dry overnight. Once the camouflage pattern is complete, remove all masking tape. **MASTER MODELER HINT:** If you used flat paints on your rocket, we suggest that you paint entire body with gloss clear spray before applying decals. Let dry completely.

To apply decals, cut each out, dip in lukewarm water for about 30 seconds, and hold until it curls. Refer to front of panel for decal placement. Slip decal off backing sheet and onto model. Blot away excess water. For best results, let decals dry overnight and apply a coat of clear Dull Cote spray to remove shine on surface and to protect the decals.

ROCKET PREFLIGHT

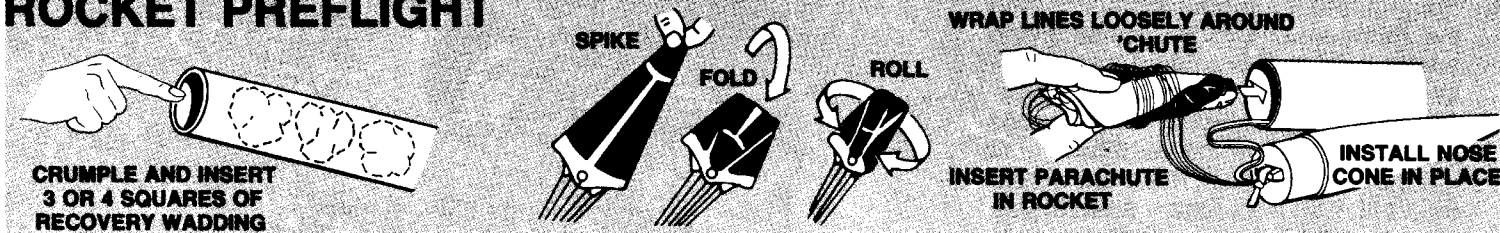

PREPARE ENGINE

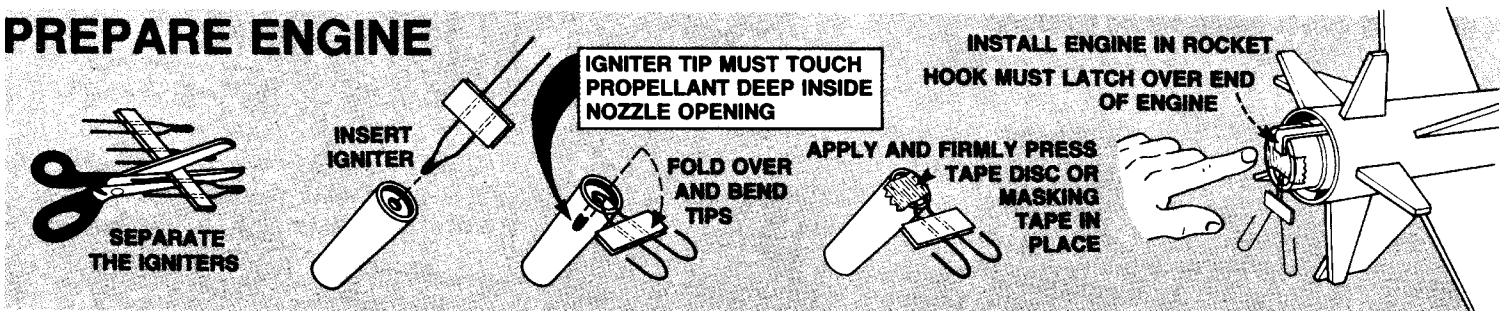

LAUNCH SUPPLIES

To launch your rocket you will need the following items:

- An Estes Electrical Launch System and Launch Pad
- Estes Recovery Wadding No. 2274
- Recommended Estes Engines: A8-3, B4-4 (first flight), B6-4, B8-5, C5-3, or C6-5.

Use B4-4 engine for your first flight to become familiar with your rocket's flight pattern.

Use only with Estes products.

FLYING YOUR ROCKET

Choose a large field away from power lines, tall trees, and low flying aircraft. Try to find a field at least 250 feet square. The larger the launch area, the better your chance of recovering your rocket. Football fields and playgrounds are great.

Launch area must be free of dry weeds and brown grass.

Launch only during calm weather with little or no wind and good visibility.

Don't leave parachute packed more than a minute or so before launch during cold weather [colder than 40° Fahrenheit (4° Celsius)].

Parachute may be dusted with talcum powder to avoid sticking.

MISFIRES

Failure of the model rocket engine to ignite is nearly always caused by incorrect igniter installation. An Estes igniter will function properly even if the coated tip is chipped. However, if the coated tip is not in direct contact with the engine propellant, it will only heat and not ignite the engine.

When an ignition failure occurs, remove the safety key from the launch control system and wait one minute before approaching the rocket. Remove the expended igniter from the engine and install a new one. Be certain the coated tip is in direct contact with the engine propellant, then tape the igniter leads firmly to base of engine as illustrated above. Repeat the countdown and launch procedure.

FOR YOUR SAFETY AND ENJOYMENT

Always follow the NAR* MODEL ROCKETRY SAFETY CODE while participating in any model rocketry activities.

*National Association of Rocketry

page 4

COUNTDOWN AND LAUNCH

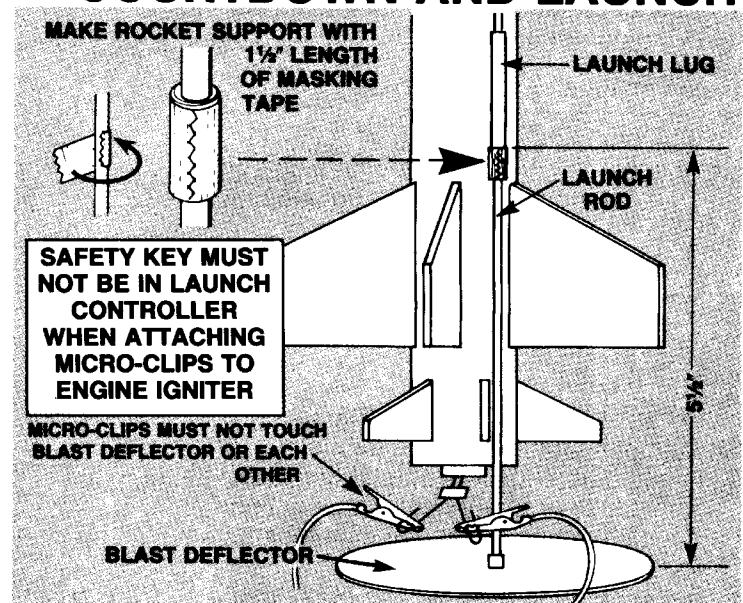

- BE CERTAIN SAFETY KEY IS NOT IN LAUNCH CONTROLLER.
- Remove safety cap and slide launch lug over launch rod to place rocket on launch pad. Make sure the rocket slides freely on the launch rod.
- Attach micro-clips to the igniter wires. Arrange the clips so they do not touch each other or the metal blast deflector. Attach clips as close to protective tape on igniter as possible.
- Move back from your rocket as far as launch wire will permit (at least 15 feet).
- INSERT SAFETY KEY to arm the launch controller.

Give audible countdown 5...4...3...2...1

LAUNCH!!! PUSH AND HOLD LAUNCH BUTTON UNTIL ENGINE IGNITES

REMOVE SAFETY KEY FROM LAUNCH CONTROLLER. REPLACE SAFETY KEY AND SAFETY CAP ON LAUNCH ROD.

84236B

ESTES PN 037461

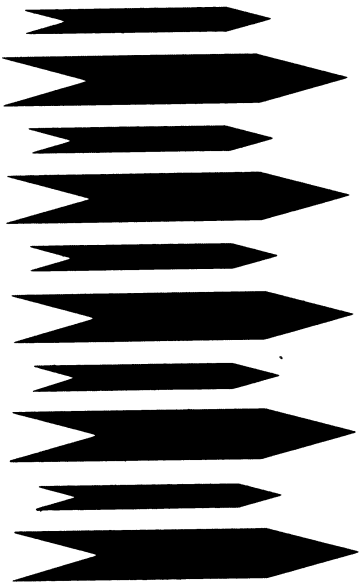
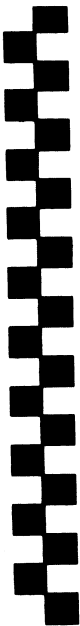
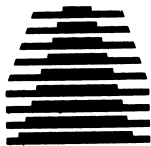
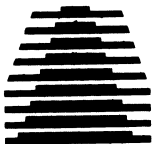
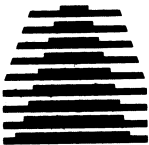

HORNET™

FLYING MODEL ROCKET

SKILL LEVEL 2

- AIRCRAFT CAMOUFLAGE DECOR
- Die-Cut Balsa Fins
- Plastic Nose Cone
- 12 Inch Parachute
- Quick-Release Engine Mount

ESTIMATED
ALTITUDES
OVER 1200
FEET!

Length: 17.75 in. (45.1 cm)
Dia: 0.975 in. (24.8 mm)
Weight: 1.17 oz. (33 g)

Recommended Engines:
A8-3, B4-4 (First Flight),
B6-4, B6-5, C3-3, or C3-5

This is a model kit requiring assembly. Glue and flying lines, launch system and parachute flight accessories included.



#2030

