



A DAMON COMPANY

Recommended for Ages 10 through Adult.
Adult Supervision Suggested for Those Under
12 Years of Age When Flying Model Rockets.

1 MODELE REQUIT Peinture et Colle non
comprises.

1 MODEL KIT Paint and Glue not included.

Flying Model Rocket

DER V-3™

FLYING MODEL ROCKET

SKILL LEVEL 2
Recommended for the Experienced Modeler.

**FLIGHTS
OVER
600 FEET!**



↑
DER ENDER
VOTS UPPER

DER V-3

- 2 Feet Tall
- Fun Decal
- 18" Parachute
- Quick-Release Engine Mount
- Die-Cut Balsa Fins

Length: 24 in.
(63.5 cm)

Dia.: 2.6 in. (66 mm)

Weight: 3.6 oz.

(103 g)

Recommended

Engines: D12-3

(First Flight),

D12-5

This kit has been designed
specifically for use only with
Estes model rocket en-
gines.

This is a model kit requiring assembly.
Glue and finishing supplies, launch sys-
tem and engines for flight are not in-
cluded. A 3/16" Dia. Maxi-Rod (#2244)
is recommended to launch this kit. - NOT
INCLUDED



#1970



A DAMON COMPANY

ESTES INDUSTRIES
PENROSE, CO 81240 USA



ROCKET ASSEMBLY

1

- Mark yellow spacer tube 1/2 inch from one end.
- Spread glue around inside of stuffer tube about 2 inches from one end.
- Insert engine block into this end.
- Push engine block into place with spacer tube until mark is even with end of tube.
- Remove and discard spacer tube immediately!

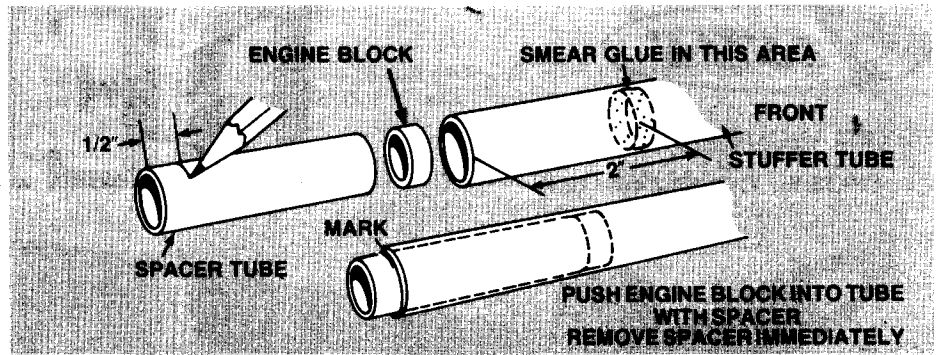

2

- Cut 1/8 inch wide slit in stuffer tube 2 1/4 inches from rear.
- Mark stuffer tube 1 inch from rear.
- Bow engine hook slightly and glue to stuffer tube as shown. Make sure the hook is straight and secure to tube with masking tape.

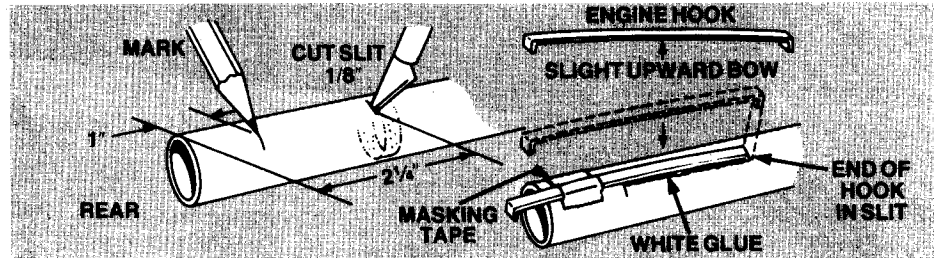

3

- Apply glue around stuffer tube above 1 inch mark for a distance of about 2 inches.
- Slide the retainer tube onto the front of the stuffer tube.
- Push the retainer tube over the glue and down to the 1 inch mark. Remove excess glue, and remove masking tape.

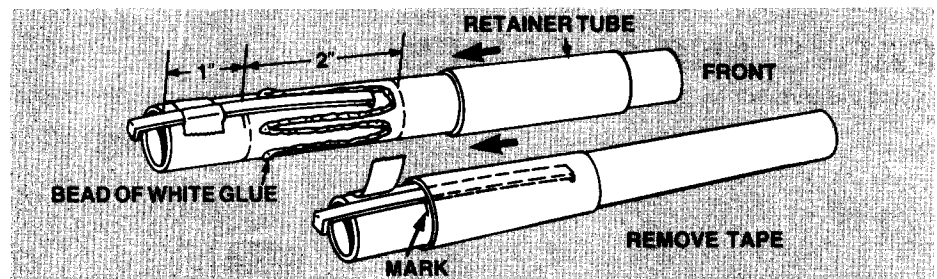

4

- Remove centering rings from die-cut card.
- Use knife blade to widen slit in one ring.
- Insert one end of the shock cord through the slit. Tie a double knot in one end of the shock cord and pull tight against slit.
- Apply glue over the knot to secure it to ring.

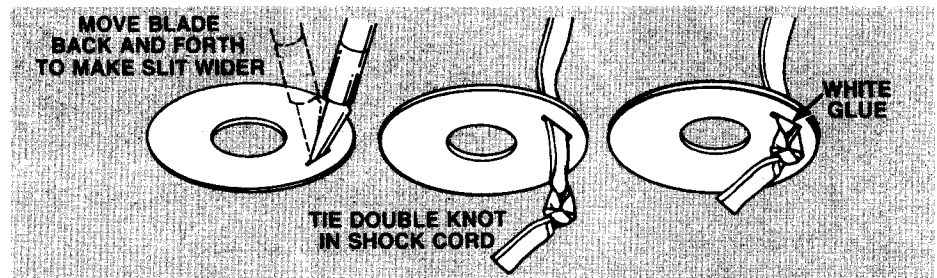

5

- Apply a line of glue around rear edge of retainer tube. Push ring without shock cord onto stuffer tube and against retainer tube edge.
- Position ring with shock cord about 1/4 inch from forward end of stuffer tube. Apply glue all around both sides of both rings where they touch stuffer tube.
- Allow all glue to dry thoroughly.

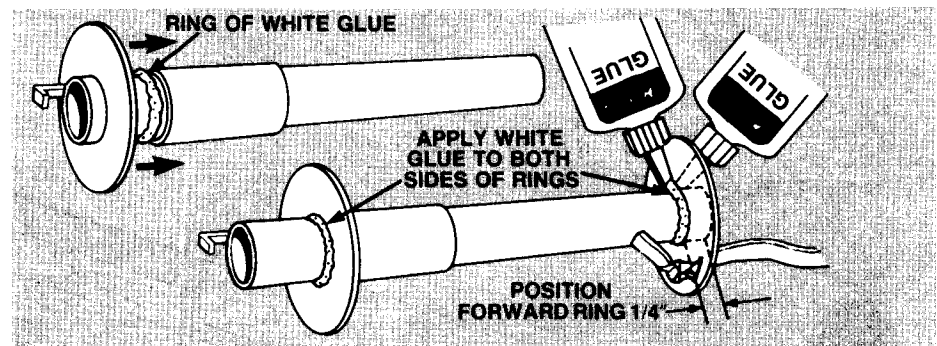

6

- Slide engine mount assembly into one end of body tube until tube ends are even.
- Apply glue all around rear tube/ring joint as shown.
- Use a small dowel or stick to apply glue all around the forward tube/ring joint. Be sure there are no gaps in the glue.

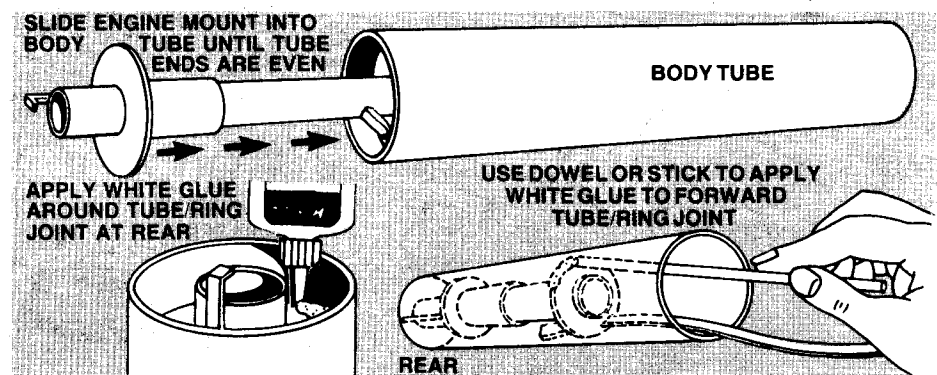



A DAMON COMPANY

ESTES INDUSTRIES
1295 H STREET
PENROSE, CO 81240 USA

DER V-3

#1970

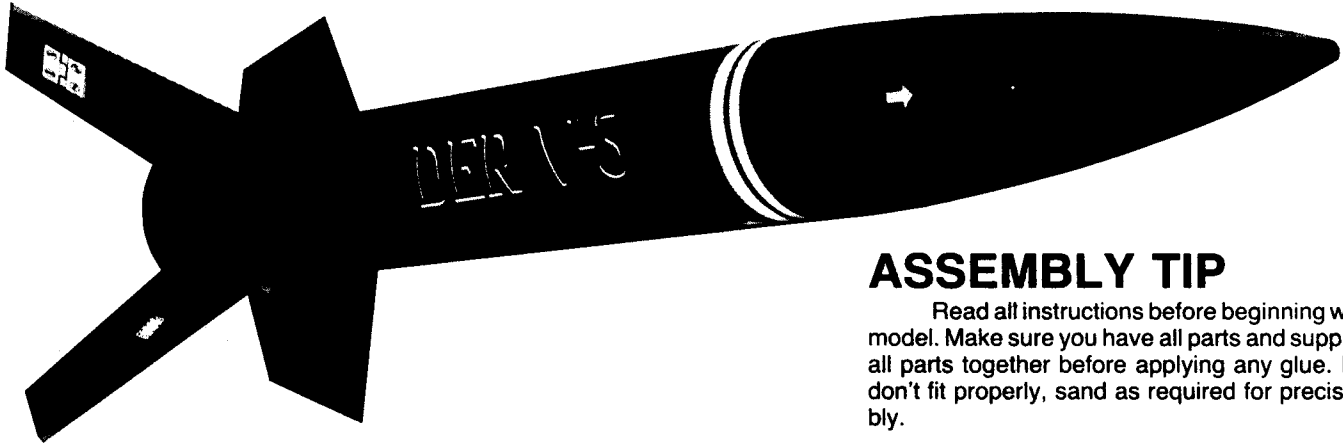

ASSEMBLY TIP

Read all instructions before beginning work on your model. Make sure you have all parts and supplies. Test-fit all parts together before applying any glue. If any parts don't fit properly, sand as required for precision assembly.

PARTS AND SUPPLIES

Locate the parts shown below and lay them out on the table in front of you. In addition to the parts included in the kit you will also need:

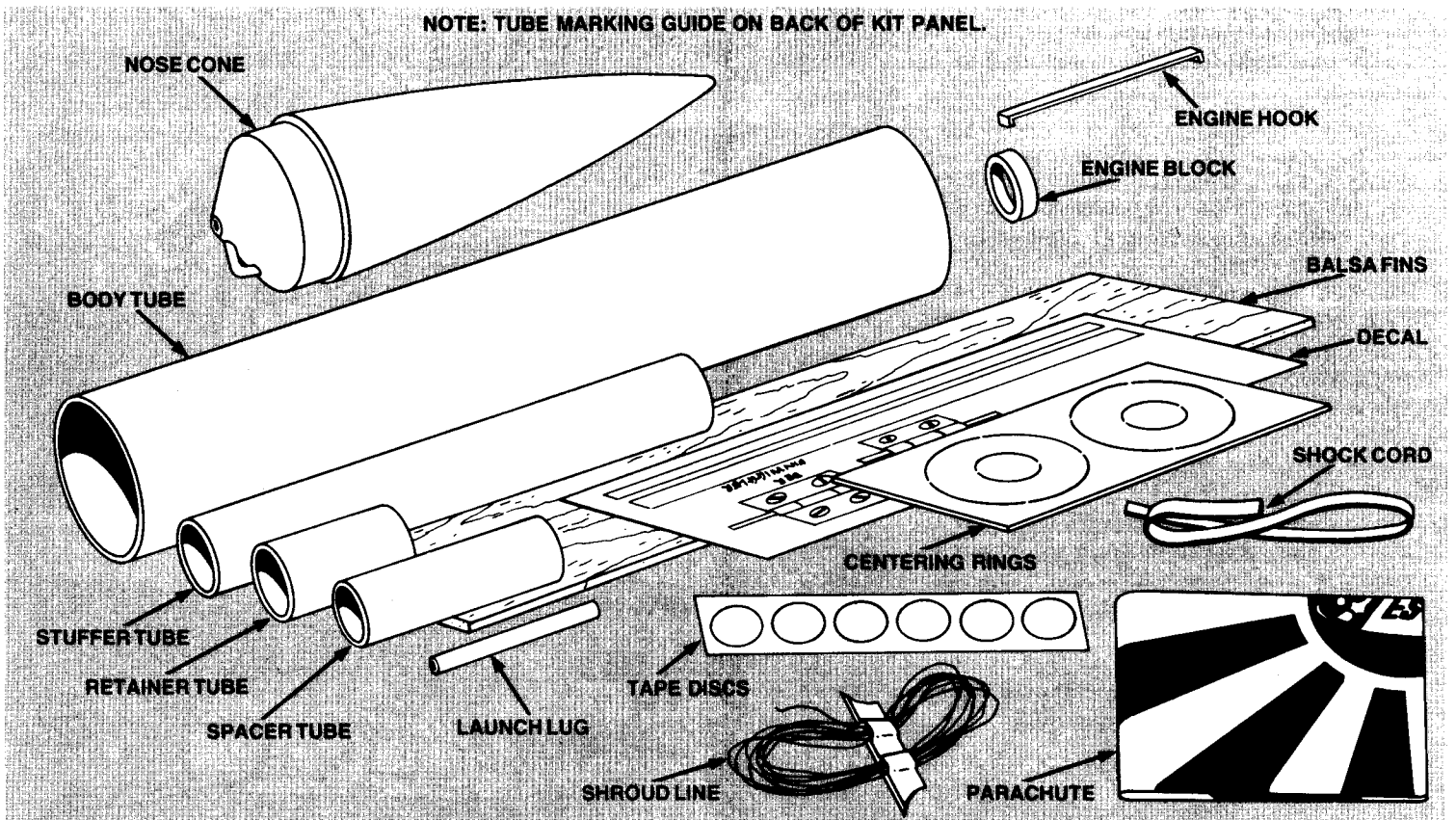
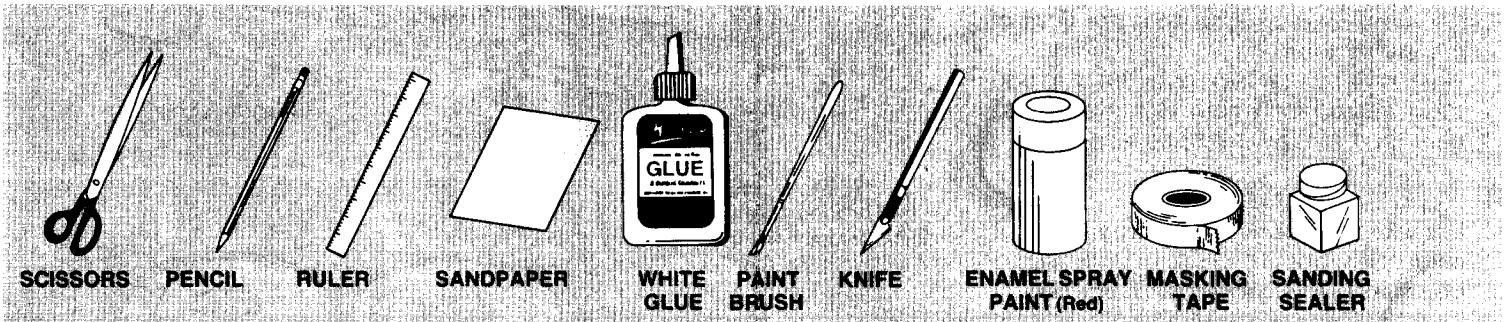

FINISHING YOUR ROCKET

Apply sanding sealer to wood parts. When sealer is dry, lightly sand all sealed surfaces. Repeat sealing and sanding until balsa grain is filled and smooth. When sanding sealer and glue are completely dry, paint model with spray enamel. Follow instructions on spray can for best results.

To apply decals, cut each out, dip in lukewarm water for 20 seconds, and hold until it uncurls. Refer to photograph on front page and/or on front of panel for decal placement. Slip decal off backing sheet and onto model. Blot away excess water. For best results, let decals dry overnight and apply a coat of clear spray paint to protect decals.

ROCKET PREFLIGHT

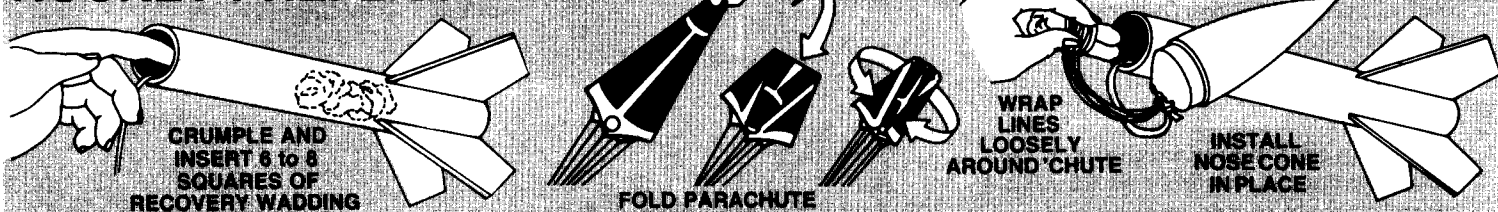

PREPARE ENGINE

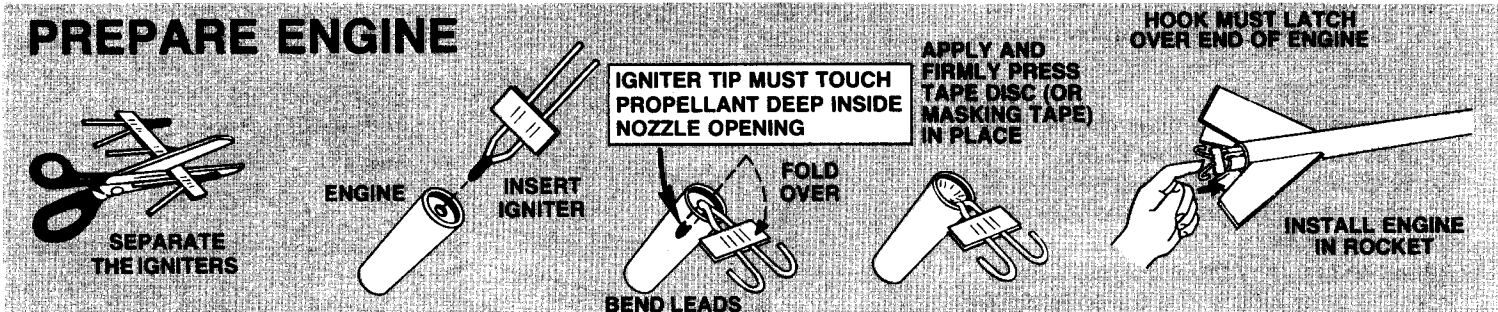

LAUNCH SUPPLIES

To launch your rocket you will need the following items:
 —An Estes model rocket launching system with 3/16 inch dia. Maxi-Rod launch rod (No. 2244).
 —Estes Parachute Recovery Wadding (No. 2274)
 —Recommended Engines: D12-3 or D12-5
 Use D12-3 engine for your first flight to become familiar with your rocket's flight pattern.

FLYING YOUR ROCKET

Choose a large field away from power lines, tall trees, and low flying aircraft. Try to find a field at least 500 feet square. The larger the launch area, the better your chance of recovering your rocket. Football fields and playgrounds are great.

Launch area must be free of dry weeds and brown grass.

Launch only during calm weather with little or no wind and good visibility.

Don't leave parachute packed more than a minute or so before launch during cold weather. [Colder than 40° Fahrenheit (4° Celsius)].

MISFIRES

Failure of the rocket engine to function properly is nearly always caused by a failure to install the igniter correctly. This failure permits the igniter to heat and burn into two pieces without igniting the engine.

FOR YOUR SAFETY AND ENJOYMENT

Always follow the NAR-HIA* MODEL ROCKETRY SAFETY CODE while participating in any model rocketry activities.

*National Association of Rocketry-The Hobby Industry of America

COUNTDOWN AND LAUNCH

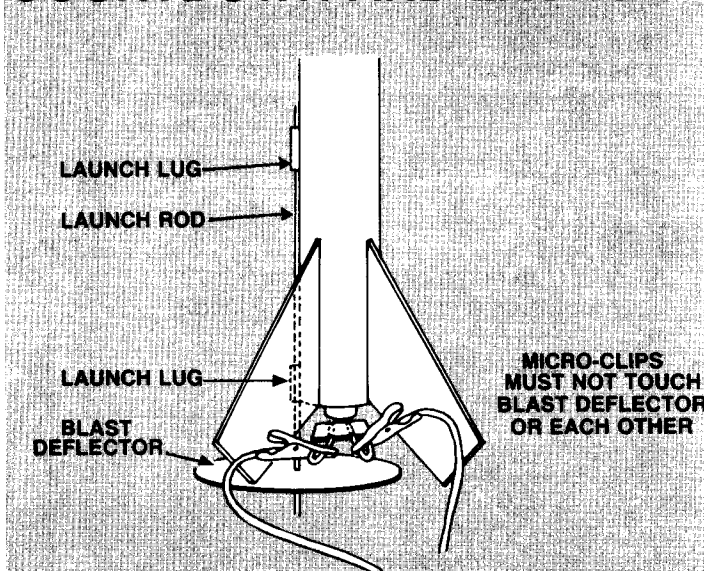

- ⑤ REMOVE SAFETY KEY to disarm the launch controller.
- ④ Remove safety cap and slide launch lugs over launch rod to place rocket on launch pad. Make sure the rocket slides freely on the launch rod.
- ③ Attach micro-clips to the igniter wires. Arrange the clips so they do not touch each other or the metal blast deflector. Attach clips as close to protective tape on igniter as possible.
- ② Move back from your rocket as far as launch wire will permit (at least 15 feet).
- ① INSERT SAFETY KEY to arm the launch controller.

LAUNCH!!! PUSH AND HOLD LAUNCH BUTTON UNTIL ENGINE IGNITES

Remove safety key—Replace cap on rod.

7

- Cut out the tube marking guide from back of kit panel.
- Wrap it around rear of body tube and secure it with tape. Mark tube at each arrow point. Remove tube marking guide.
- Draw straight lines connecting each matching pair of marks. (A door sill works well for this.) Extend all lines about 8 inches from rear of tube.

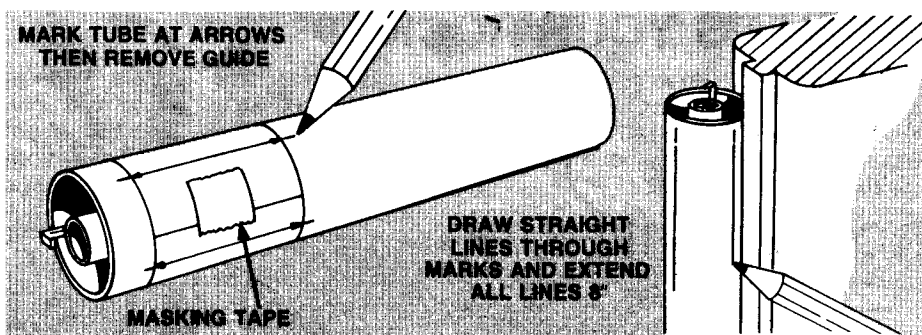

8

- Fine-sand both sides of balsa fin sheet. Carefully cut out fins from sheet. Use a modeling knife to free corners.
- Stack fins together as shown. Sand fins until all edges are smooth and straight.

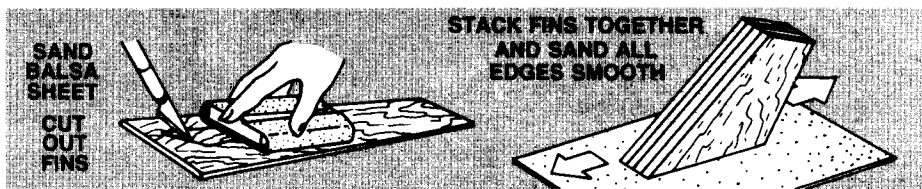

9

- Rub a small amount of glue into the root edge of each fin and allow to dry.
- Apply glue to the fin root edges (one at a time) again, and position them on the fin alignment lines.
- Adjust fins so they project straight away from the body tube and are also straight along the tube. Do not set the rocket on its fins while the glue is wet.
- Cut the launch lug into two 1 inch lengths. Now glue the launch lugs on the body tube at the positions shown. Be sure the launch lugs are straight before the glue sets.

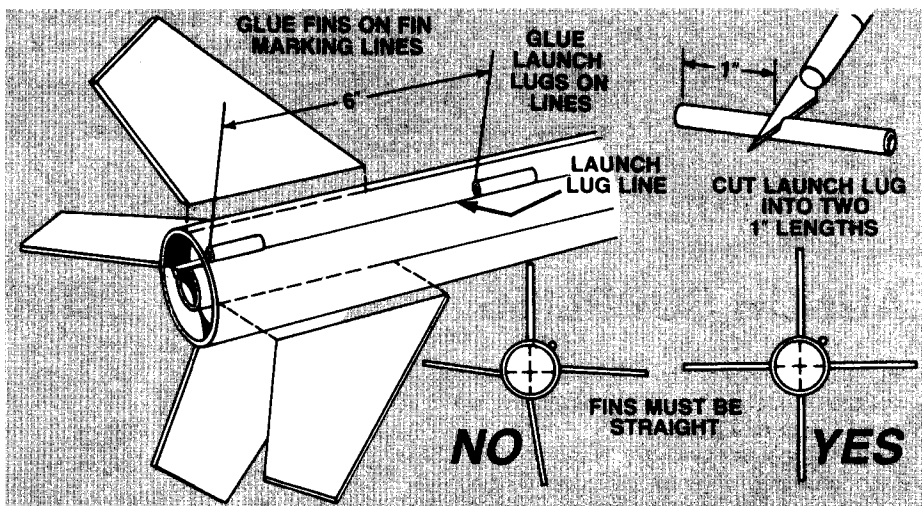

10

- Apply a glue reinforcement to each fin/body tube joint and each side of launch lug.
- Support rocket as shown until glue dries.

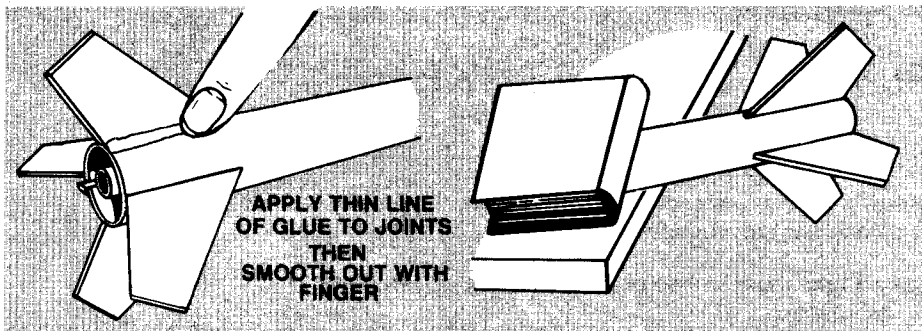

11

- Cut out parachute on edge lines.
- Cut three 35 inch lengths of shroud line.
- Form small loops with shroud line ends and press onto sticky side of tape discs.
- Attach tape discs with line ends to top of parachute as shown.
- Firmly press tape discs into place until both tape discs and parachute material are molded around shroud line loops.
- Pass shroud line loops through eyelet on nose cone. Pass parachute through loop ends and pull lines against the nose cone.
- Tie free end of shock cord to nose cone eyelet.

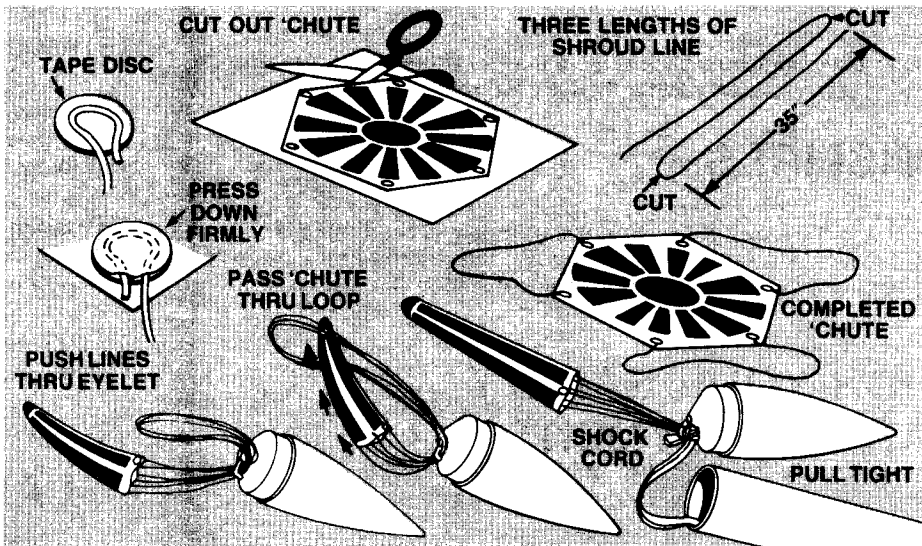

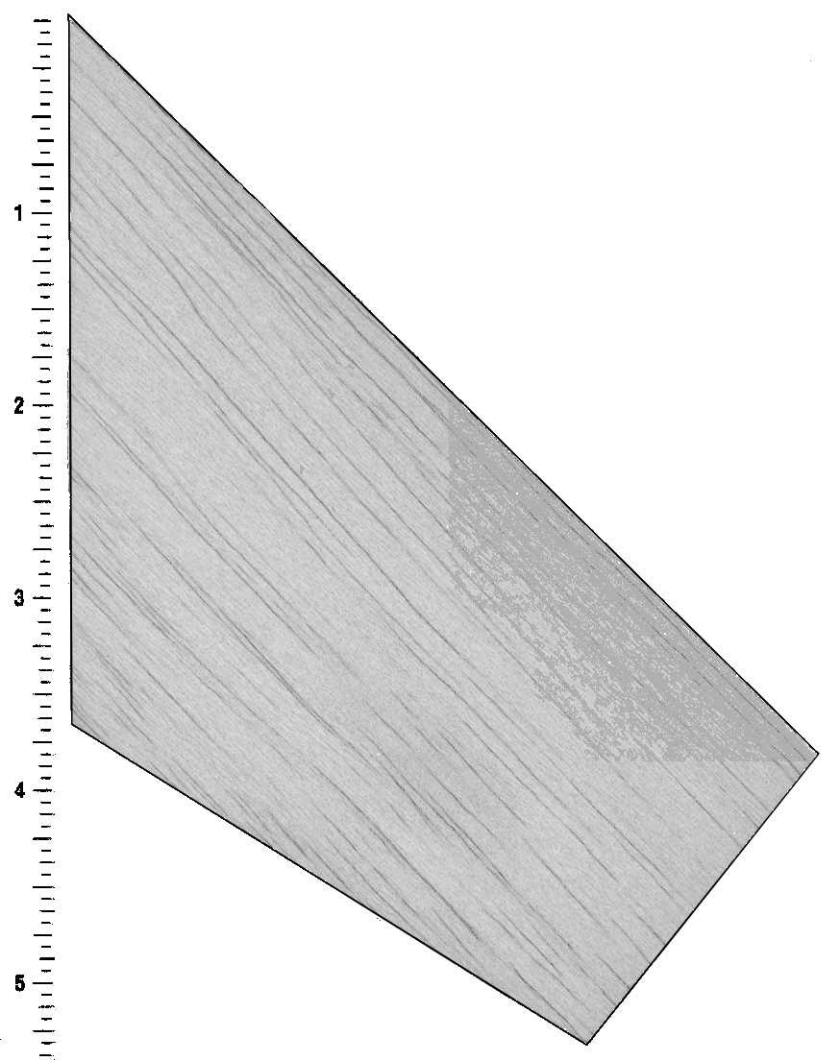

**TODAY
1953**

S	M	T	W	T	F	S
JANUARY						
				1	2	
3	4	5	6	7	8	9
10	11	12	13	14	15	16
17	18	19	20	21	22	23
24	25	26	27	28	29	30
31						

FEBRUARY						
	1	2	3	4	5	6
7	8	9	10	11	12	13
14	15	16	17	18	19	20
21	22	23	24	25	26	27
28						

MARCH						
	1	2	3	4	5	6
7	8	9	10	11	12	13
14	15	16	17	18	19	20
21	22	23	24	25	26	27
28	29	30	31			

APRIL						
		1	2	3		
4	5	6	7	8	9	10
11	12	13	14	15	16	17
18	19	20	21	22	23	24
25	26	27	28	29	30	

MAY						
					1	2
3	4	5	6	7	8	9
10	11	12	13	14	15	16
17	18	19	20	21	22	23
24	25	26	27	28	29	30
31						

JUNE						
	1	2	3	4	5	
6	7	8	9	10	11	12
13	14	15	16	17	18	19
20	21	22	23	24	25	26
27	28	29	30			

JULY						
		1	2	3		
4	5	6	7	8	9	10
11	12	13	14	15	16	17
18	19	20	21	22	23	24
25	26	27	28	29	30	31

AUGUST						
1	2	3	4	5	6	7
8	9	10	11	12	13	14
15	16	17	18	19	20	21
22	23	24	25	26	27	28
29	30	31				

SEPTEMBER						
		1	2	3	4	
5	6	7	8	9	10	11
12	13	14	15	16	17	18
19	20	21	22	23	24	25
26	27	28	29	30		

OCTOBER						
				1	2	
3	4	5	6	7	8	9
10	11	12	13	14	15	16
17	18	19	20	21	22	23
24	25	26	27	28	29	30
31						

NOVEMBER						
	1	2	3	4	5	6
7	8	9	10	11	12	13
14	15	16	17	18	19	20
21	22	23	24	25	26	27
28	29	30				

DECEMBER						
		1	2	3	4	
5	6	7	8	9	10	11
12	13	14	15	16	17	18
19	20	21	22	23	24	25
26	27	28	29	30	31	

B203

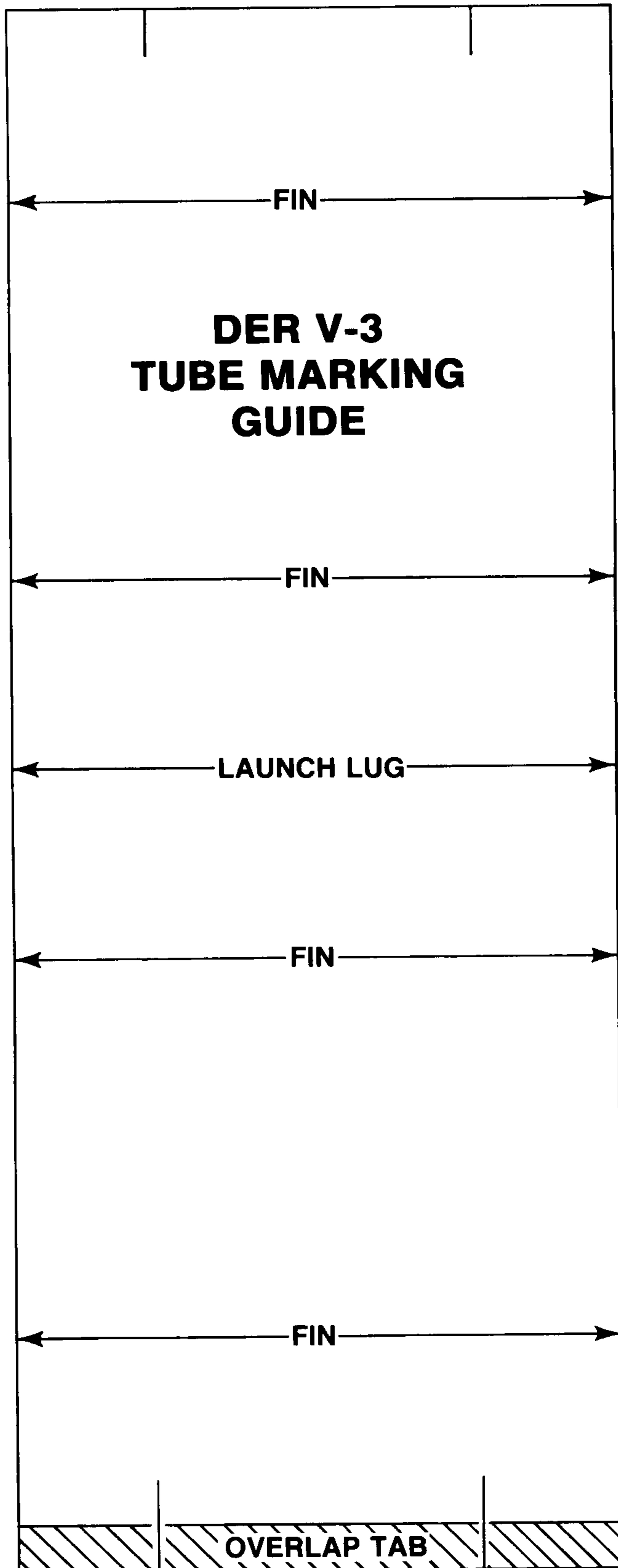

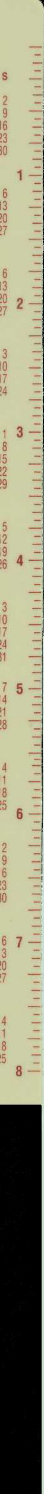

KEEPEN DER
MITTSOUTEN



PATCHWERK



DER LUGSFER LAUNCHEN



DIER V-3

DER
FIN WIGGLER

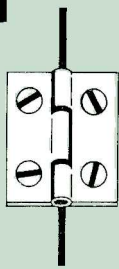

DER
FIN WIGGLER

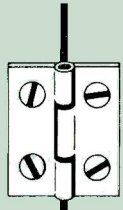

DER CHUTE
COMENOUTEN



DER ENDER
VOTS UPPER



ESTES IND.
PN 37287

Estes Der V-3 Parts List

1. Nose Cone BT-80
2. Body Tube BT-80, 14 3/8" long
3. Stuffer Tube BT-50, 7 11/16" long
4. Retainer Tube Slides over BT-50, 2 1/8" long
5. Balsa Stock 1/8" thick
6. Centering Rings CR 50-80