

# M O D E L ROCKET

ESTES INDUSTRIES SPRING 1993

**NEWS**

Vol. 33, #1, Issue 90

## THE LEADING EDGE GIMME AN "E"!

"We want an E engine!"  
"You NEED to have an E engine."  
"We need an E engine."

It was told to us in a convincing fashion and we told it to ourselves in plain language, "We have an Astro-Blaster™ that flies on D's but, boy, it would be a pure aerial circus if you could shove an E in it." We have other rockets whose performance could be more exciting

with an E - Saturn V™, Optima™, and Super Big Bertha™. So doing what we do best, we developed a new engine to join the long line of famous Estes engines - the Cobra™ E15. It uses the same safe solid propellant for which Estes model rocket engines are famous (Fooled you, didn't we?).

*Continued on page 2*

Inside this 92nd issue of the "Model Rocket News" you will find a great boost glider plan called the "Lizard"; the conclusion of the All American Alpha saga; and a "Tangents" article on a space time capsule called SpaceArc. Also in this issue, Art Nestor takes us back to 1970 in his continuing series, "Estes of Yesteryear". Enjoy!

## ESTES PRO™ SERIES

Estes Industries welcomes you, the adult model rocket enthusiast, to the world of the Pro™ Series. More than a skill level, Pro™ Series is a product line. It has its own characteristics and requirements. In the Pro™ Series you will find rockets of single, clustered and multi-staged construction that will require higher total impulse engines than you will find in other Estes rocket series. This means kits with single or staged E's and F's (F's in the near future, G's a little further down the road) and kits with clustered D's, E's and eventually F's. Because these engines are larger and more powerful, they will require a little more flight preparation and more advanced or detailed construction techniques. That does not necessarily mean that these kits will be difficult to build. They can be as easy as our E2X™ Series or as difficult as a Saturn V™ rocket.

*Continued on page 2*

MODEL ROCKET ENGINES

# GIMME AN "E"!

Continued from page 1

If you like the smoke and fury of the D's, especially when clustered, then what can I tell you - the E's double your pleasure. What's so great about this engine (other than the fact that it is an E engine)? If you know how to use the other engines in the Cobra™ line, you will have no problem using this engine. It uses Estes standard igniters and comes with our patented igniter plug technology so it's just as easy to use as an Estes A8-3. This engine will "rock and roll" in clustered and staged designs. In the past, many E engines developed by other manufacturers have been less than reliable. The new Estes E engine has been designed for safety and reliability.

The E15 for 1993 will come in four, six and eight second delays. In addition, there will be a plugged (no delay or ejection charge) E15-P for our Astro-Blaster™ fans. The E15 specifications are as follows:

Total impulse is 32 Newton-seconds with a burn time of 2.4 seconds.

The physical specifications of these engines are different from our other engines. The E's will be the same diameter as the D's and only 3/4 of an inch longer. The thrust curve looks like this (the D engine curve is shown for comparison):

Engine Type	Total Impulse		Average Thrust		Propellant Weight
	Pound-seconds	Newton-seconds	Pounds	Newtons	
D12	4.48	20.00	2.85	11.80	0.05496 lb.
E15	7.14	32.00	2.85	12.80	0.07720 lb.

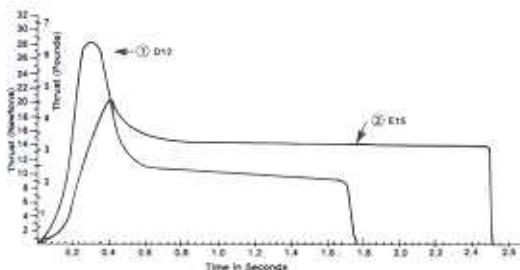

You will notice that the E engine peak is lower than the D's, however, the total impulse is made up by the long burn. This is why this exciting new addition to the Estes line is to be viewed as a sport engine - a kick in the pants, put-a-smile-on-my-face engine. As you can see from the curve, full thrust isn't generated until 0.2 seconds into the burn. This allows for slow, realistic lift-offs. The burn con-

tinues for a very satisfying 2.20 seconds (which in terms of a model rocket is a 1-0-n-g time). The burn time on the E15-P is even longer since the space taken up by the delay and the ejection charge is replaced by propellant. This will give the R/C pilot a little more altitude to play with. You should expect about 500 to 600 feet altitude with the Astro-Blaster™ on the E15-P. Now the E15 isn't a loadlifter (the recommended maximum liftoff weight is less than the D) and it isn't a sprint engine, but it's a marathon engine. It will keep pushing a rocket when the D engine has long quit. This "soft" E is great for medium to large rockets or boost gliders. And, because this is a low impulse E and thus generates less drag in a rocket, it is perfect for those high performance designs. It also means this E won't cause your rocket to exceed the "speed of balsa" causing fins to be stripped away due to high aerodynamic pressures (like high speed). However, if you cluster with this engine, you'd better use the heavy duty construction rockets in the Pro™ Series. There is no E15-0 available yet, but consider this two stage combination: D12-0 in the lower stage and an E15-8 in the top stage. This thrilling, out-of-sight combo in a, let's say, modified Magnum™ would give you a total burn time of almost four seconds.

Now before you jam this E into any of your old D engine designs, please remember this engine is 3/4 of an inch longer than the D. Make sure your rocket is stable with this engine and is well built. If your rocket is stable with this E and your rocket has an engine hook, you might want to bend back or trim off the end of the hook. Remember if you do that, you will always have to securely tape your engine in place. If you have any unbuild D-powered kits, you might want to convert them over to E engines right from the "get-go". You will need to make a few modifications such as a 3 1/2" long engine tube (BT-50 or equivalent)

Continued on page 19

## Estes Pro™ Series

Continued from page 1

Why have we introduced this series to you? You may be one of our many loyal modelers who has peaked out on D-powered rockets and you now seek greater challenges to keep your interest. Or you may belong to another segment at which we have aimed the Pro™ Series and that is the B.A.R. - the "born-again rocketeer". B.A.R.s are modelers who have explored this hobby ten, twenty or even thirty years ago. You may have stepped out of the hobby for various reasons, perhaps because of the lack of challenge. Perhaps now you may have children who have discovered rocketry and it has rekindled your interest. But what you really want are greater challenges, bigger engines, bigger rockets. The Pro™ Series is the answer for you. Let us now focus on some of the specifications found in our Pro™ Series.

## GROUND SUPPORT EQUIPMENT

Pro™ Series, because of the engine power and the size of the rockets, has some special requirements not needed with the lower powered rockets. In most Pro™ Series kits, the power required to get these rockets off the ground can be in excess of 40 Newtons (equivalent to two D's). Whereas, the launch crew and spectators should be about 15 feet away from A through D-powered rockets, Pro™ Series rockets require an additional margin of safety. The NAR (National Association of Rocketry) Safety Code requires 30 feet of distance. Why? Usually rockets that need E's to get off the pad can be larger and heavier. The additional 15 feet gives you that extra margin of safety. The heart of the Pro™ Series launch system is the Command Control™ launch controller. The Command Control™ features function, power and safety not found anywhere else. The Command Control™ has 30 feet of 18 gauge wire with a special whip clip to make engine clustering easy and simple. The power is supplied by one or two 7.2 volt NiCad rechargeable (R/C car type) batteries (not included). The batteries do not have to be removed from the controller to be recharged. In addition, the Command Control™ can be easily adapted to take an external power supply. The safety features that make the Command Control™ stand out include a system that requires two buttons to be pushed

## MODEL ROCKET NEWS

Editor . . . . . Mike Hellmund  
Art Director . . . . . Rob Akey  
Design . . . . . Kathy Seamon  
Typesetting . . . . . Karen Oelschlagel  
© Copyright Estes Industries,  
1993. All rights reserved.

for launch (for added launch safety). There is both audio and visual continuity checks, so you will always know the status of your launch. The Pro™ Series Command Control™ launch controller provides you confidence as it will safely ignite Pro™ Series rockets (as well as most consumer rockets) from 30 feet away. The wiring is of a large enough gauge to be able to handle ignition of multi-engine clusters. The lower powered launch systems that Estes has (the E2™ and the Electron Beam™) cannot be used for cluster applications because the gauge of the wire is thin and thus has a high resistance. This high resistance prevents sufficient amperage to ignite a cluster of igniters. If you only managed to ignite one engine in a cluster, your rocket will suffer serious consequences - instability and lack of power. In addition, if you were clustering D's (in excess of 40 Newtons), the leads would not be up to the 30 foot safety requirement.

Because of the size of the Pro™ Series rockets there are additional requirements for the launch pad. First, the launch rod needs to be sturdier and more rigid than those used in smaller rockets. If you watch slow motion video of a rocket launch, you will notice that the rod flexes at launch. If the rod is the standard 1/8" or even 3/16" diameter, this could cause the rocket to literally veer off the pad in a less than desirable direction. A 1/4" rod reduces this flex to the amount found with smaller rockets. For the same reasons, the pad itself must be more stable. The footprint (or how it sits on the ground) needs to be wide enough to handle rockets that can weigh several pounds. The pad needs to have an easily adjustable trajectory (no more than 30 degrees from vertical). With the Estes Power Plex™ launch pad and the Command Control™ launch system, Estes has delivered a system that can handle rockets weighing up to five pounds. The Power Plex™ pad has a wide (40 inch) footprint, its trajectory can be easily adjusted by loosening and tightening the large ball joint. It comes equipped with a two-piece, screw-together, 1/4 inch launch rod. The pad can also handle 1/8" and 3/16" rods so it is perfect for the lower powered rockets too. The Power Plex™ is sturdy but lightweight, easy to set up and easy to collapse, unlike other

commercially available launch pads for larger rockets. These two ground support equipment pieces will provide you the safety, enjoyment and reliability you need for the rockets of the Pro™ Series class.

## ROCKETS

As we have mentioned, the rockets found in the Pro™ Series are bigger and heavier. To be able to handle the higher thrust and weight, the construction needs to be beefier and stronger. This means thicker-walled body tubes along with launch lugs that can take the 1/4 inch launch rods. The engine mounts need to be heavy duty to handle the extra power. Because the rockets are heavier, plastic parachutes will not work. They may shred and shroud lines may rip loose. The fins need to be strong and securely attached.

All the rockets in the Pro™ Series have thick-walled body tubes. This gives the longer rockets the rigidity and strength they need. The tubes have been slotted so that fins can be mounted directly to the engine mount. This gives you a very strong bond for both the engine mount and fin. The engine mount consists of a thick-walled engine tube and plywood centering rings. The plywood rings stand in sharp contrast to the heavy card rings of the lower powered kits.

With the fins, Estes has found a good compromise between heavy duty and lightweight. Contrary to



popular belief, fins do not need to be heavier to be stronger. With the pro™ Series, Estes has used a form of composite fin design. On many kits you will find a balsa center section that is framed with spruce strips. This construction coupled with the through-the-body tube wall mounting gives you a very strong, yet lightweight fin design. Lighter weight will provide you with better performance. The shock cords are 1/4" wide elastic bands and the parachutes are made from high-visibility, rip-stop nylon with the shroud lines sewn into the 'chute. This will give you reassurance that your rocket will be recovered safely and undamaged.

The Pro™ Series rockets require the strength that epoxy glues and cyanoacrylate provides. It is strongly recommended these type glues be used in the construction of rockets in this series. (Please note that Pro™ Series is recommended for adults. We do not recommend the use of cyanoacrylate in rocket construction by those under 16 years of age).

## ENGINES

As of the time this article is published, Estes has introduced the Cobra™ E15 engine. This engine is made from the same proven propellant as Estes D and lower powered engines. This means safe, consistent, quality engines.

The E15 uses popular Estes igniters and the patented igniter plug technology for reliable ignition every time. This engine can be easily clustered

*Continued on the next page*



# IDEA BOX



From Terrill A. Young,  
Cincinnati, OH

Many of the flowers-by-mail companies now use a long, hollow, styrofoam box to protect their long-stemmed flowers from both temperature and abrasion. Such boxes are about six to eight inches square in cross section and about thirty inches long. With slight modification for fin fitting, these boxes make ideal, crush-proof and ultralight rocket carriers. (You may want to add an inexpensive handle to make carrying less awkward.)



From Philip Balduc,  
Saint Albans, VT

Retrieve your recovery wadding after each flight and use it again. Be careful not to use it too much (three flights or so, depending on the engine used) or else it won't protect the rocket's recovery system effectively.



From Ron Sindric,  
Lame Deer, MT

A model airplane locking wheel collar can make an excellent blast deflector stand-off. Attach it to a launch rod when you do not want your model rocket to touch the deflector plate. It is a little bit nicer than using a strip of masking or duct tape.



From Bill Edwards,  
Fayetteville, NC

When applying self-adhesive decals it is a good idea first to wash the oils and dirt from your hands. Next, add a couple of drops of dishwashing soap to a small bowl of warm water. Remove the decal from the backing sheet after moistening your fingertips and the surface the decal will be applied to. Dip the decal in the water and apply to the surface. If you don't like the position, simply use your hobby knife to lift the decal edge. Remove and reposition the decal. This can be done countless times. After it is properly positioned, simply blot dry. Make sure that no water is trapped under the decal. Use your hobby knife to remove the clear portions for a professional appearance. I have used this technique on the Bandit™. It works very well.



## engines

Continued from page 3

and even staged with a D12-0 booster engine. *Editor's Note: Please see the other "Leading Edge" article for more information on our new E15.*

To learn about clustering, see the last issue of the MRN for a QuickTech report on clustering. Every clustered Pro™ Series kit provides you with information on engine clustering.

## FLYING REQUIREMENTS

The 30 foot launch leads, the 1/4" launch rod or even the nylon parachutes are not the only safety items of which you need to be aware. Remember, you are flying

larger rockets with higher power. You need to be aware of many things such as aircraft flying over your launch area. You need to make certain spectators are aware of the launch and away from the launch site. You should avoid flying in too breezy conditions. Your flying field should be sufficiently large to handle rockets that can fly one, two or even three thousand feet. The sides of your launch site should be at least one fourth to one half as long as the altitude you expect. That means with a 1000 foot expected altitude, your flying field should be at least 250-500 feet on a side. Perhaps some of the most important requirements are those imposed by the FAA (Federal Aviation Administration). Any rocket that weighs more than a pound (16 oz.) and/or has more than 4 oz. of propellant (more than two Cobra™ E15s or four D12s) require that you contact the local FAA office to file a notification or even a waiver. The only Estes kits that currently require such action would be the Pro™ Series Maxi-Force™ and the Pro™ Series Patriot™. Each one of these kits contains information on how to proceed with a notification and/or how to procure a waiver. Your favorite Estes retailer should have that information too! It is not a difficult procedure but it is required by law. The notification or waiver allows the FAA and pilots to know where you are flying heavy rockets. It's for your safety and theirs and it is your responsibility when flying very large, heavy Pro™ Series rockets. Changes have been requested that may raise those limits in the near future. We at Estes, through this publication and through your retailer, will let you know when and if these limits are raised.

## SO...

Grab a friend, your Pro™ Series equipment and rockets. Experience the smoke and fury. Estes has provided you the finest equipment. And the Pro™ Series is available everywhere. Estes is the only rocket company with the support of thousands of retailers from coast to coast. We're the only company able to offer you the confidence of over 35 years of proven technology and an excellent safety record. Fly 'em high, fly 'em safe.

# TANGENTS

## COMMUNICATE ACROSS TIME AND SPACE THROUGH *SPACEARC: THE ARCHIVES OF HUMANITY*

It has been our eternal desire to communicate across the barriers of time and space. Mankind first reached out as much as 20,000 years ago to leave us his first piece of communication - a handprint on a cave wall.

Today, thousands of people from around the globe are documenting our world and our time through SpaceArc: The Archives of Humanity, an international, high-tech time capsule of words and images created by individuals of all ages for launch on board a Hughes Communication satellite into Earth orbit in 1994.

SpaceArc is a not-for-profit educational project initiated by the Rochester Museum & Science Center (Rochester, NY) and developed in partnership with NASA (Educational Affairs Division); Hughes Communications and DirecTV; Space Systems/Loral; Educational Testing Service; the Canada Centre for Remote Sensing; ICI Americas, Inc.; Creo Products, Inc.; Compton NewMedia; the Voice of America radio network; and the World Space Foundation.

To participate in SpaceArc, individuals inscribe essays, drawings, poetry and written musical scores on SpaceArc forms. There is also space on the form for the participant's picture. Completed forms will be optically scanned and stored as digital messages for launch on board a Hughes Communication satellite which will be placed into geosynchronous Earth orbit in mid-1994.

Duplicates of the SpaceArc time capsule will be available at computer-based Earth Stations in strategically located museums and science centers around the world to provide long-term access for education and cultural sharing.

The data will be stored on optical tape and launched aboard the Hughes DirecTV satellite in July 1994. After an expected twelve years of service life, the vehicle will be boosted into a long period geosynchronous orbit that is expected to last 100 million years.

SpaceArc will also carry Compton's Multi-Media encyclopedia in CD-ROM to serve as a key to the archive and to present an even fuller picture of our world. From the

Canada Centre for Remote Sensing, SpaceArc will receive a copy of the Geoscope Interactive Global Change Encyclopedia, a database of satellite images compiled by more than 40 space agencies in conjunction with the International Space Year to provide a comprehensive overview of man's impact on Earth's environment.

Individuals who participate in SpaceArc also become members of the International SpaceArc Society and receive recognition as contributors to the archive. To submit a message to SpaceArc and

Through SpaceArc, a preschooler can express her love for her baby brother, a 12-year old can discover the inspiration to study for a career in space science and a senior citizen can record reflections on a long, full life. To date, more than 30,000 individuals from some 34 nations have participated.

Submissions already received for SpaceArc range from a Mexican mother's concerns about the world her children will inherit, to a Nigerian college student's greeting of universal friendship, to a Czechoslovakian engineer's design for a system to bring fluoridated water to even the smallest village.

Though it has the potential to store millions of messages, SpaceArc is for and about the individual. It invites each one of us to define for ourselves who we are, what we are, and what we want to convey to future generations.



Here are two examples of the messages that will be loaded onto SpaceArc. On the left is Rosalyn Chan and above is Science Fiction great Arthur Clarke.

Continued on page 8



# FOOTPRINTS on the MOON

## ESTES of Yesterday

By Art Nestor,  
NAR #29623,  
Zelienople, PA

# 1970



was an exciting and eventful year for space programs of all sizes. As the nation's attention was frequently focused on the U.S. and Soviet space efforts, Estes Industries continued to "throttle up" in the heyday of our hobby. Join me in a review of Estes model rocketry, vintage 1970.

Although I tend to agree with other collectors and old-timers that the 1971 catalog was the best ever produced (*Editor's Note: Of course, Art hasn't seen the exciting, brand new 1993 catalog yet!*), no one can dissuade me from my opinion that the front cover of the 1970 catalog was the most attractive (see photo). Surely others come close, but this one is my favorite. Featured is one of Estes' most

beautiful and intricate rocket kits, the Orbital Transport™. First introduced in 1969, the Orbital Transport™ was Estes' version of an early concept of the space shuttle. Against the starry blackness of space and a fertile blue Earth, one transport is attaining Earth orbit, while a space shuttle is separating from a second one.



2 Stage Omega™

Not counting covers, this catalog (#701) is a whopping 144 pages. In the center, a yellow-paged model rocketry technical manual comprises 32 of those pages. No other versions of this catalog are known by me to exist. Prices became effective April 15, 1970. This catalog is notable for introducing the famous Estes logo as we know it today, except that the Estes lettering was black and not blue. It was also the first

catalog published by Estes Industries after the company became a subsidiary of the Damon Corporation in late 1969. Many new products were introduced in previous years but did not appear in a catalog until 1970. For this reason, it is difficult to accurately date when some items were first offered for sale. New products such as the Estes D engine and the spectacular Cineroc™ aerial movie camera are covered here because it is believed to be their first appearance in an annual catalog.

The Cineroc™ used Super 8mm color film in a convenient film cartridge. As with the Camroc™ (Estes' first aerial camera, which is still available), the film and processing were supplied by Estes Industries. Utilizing an optics hood with mirror like the AstroCam™, the Cineroc™ was a rearward-filming camera. However, little assembly was required. Incredible footage of ignition, liftoff, stage separation, and parachute deployment could now be viewed. If you didn't own a movie projector, then a hand-held, hand-cranked viewer could be purchased for \$4.95. The Astron Omega™ was a special two-stage booster designed to loft the camera using one D engine in each stage. Today, a brand new unused Cineroc™ can bring as much as \$250.

## CINEROC™ SPECIFICATIONS

10 mm focal length lens  
F11 - 1/500th second shutter  
30 frames per second  
6" to infinity depth of field  
Weight fully loaded: 3 ounces  
Length: 9.9"  
Fits BT-60 body tube  
Diameter: 1.75"  
Cost: \$19.95

The Estes D engine made its debut as a D13 in mid 1969 and not as a D12 as it is commonly known today. Apparently, Estes made a labeling mistake and their D engine was labeled as a D13 for the first two years. The revised 1971 (catalog #712) engine chart and all others afterwards list it as a D12 with no visible change in size, propellant weight or thrust. In fact, a 1970 list of catalog corrections describes the Series IV (D13) thrust curve on page 85 as incorrect. The corrected thrust curve shows a lower sustaining thrust. This would seem to dispel the oft-heard rumor surrounding the labeling change that the original Estes D engine was slightly downgraded in power because it was prone to catastrophic failure. They sold three for \$2.00.

Several other engines made their first catalog appearance in 1970. They were the Estes short engines: A5-0S, A5-2S and the A5-4S. There were a total of 39 engines for sale. No engines were discontinued in 1970.

There were a total of 51 rocket kits available. The following kits made their catalog debut: Beta™, Cherokee D™, Omega™, Shrike™, Sprint™ and the Star Blazer™. Some of these kits were available before 1970 through the MRN or Estes' free kit offers. I flew the Star Blazer™ in 1967. But remember, we are only dealing with first time catalog appearances.

Kits returning to the 1970 lineup were: Aerobee 300™, Alpha®, Apogee II™, Apollo Capsule™, Arcas™, Avenger™, Big Bertha™, Birdie™, Cobra™, Constellation™, Delta™, Drifter™, Falcon™, Farside X™, Gemini Titan™, GT-3™, Gyroc™, Honest John™, Little Joe II™, Mark™, Mars Lander™, Mars Snooper™, Mercury Capsule™, Mercury Redstone™, Midget™, Nighthawk™, Orbital Transport™, Phantom™, Ranger™, Saturn 1B™ (1/70 scale), Saturn V™ (1/242 scale), Saturn V™ (1/100 scale), Scout™, Scrambler™, Sky Hook™, Spaceman™, Space Plane™,

Sprite™, Starlight™, Streak™, Thor Agena B™, Trident™, V-2™ WAC Corporal™ and X-Ray™. No kits were discontinued from 1969.

The only other product worth noting here would be the Phantom Electro Launch™. The pad and controller were made of clear plastic enabling the rocketeer to see the batteries and inner connections.

However, Estes Industries did release a 16mm color and sound motion picture that year entitled, "T Minus One and Counting". The 11½ minute movie was filmed at the Air Force Academy in Colorado Springs, CO during NARAM 11 (1969) and was available on a free loan basis to qualified groups. It provided coverage of the national meet and very early footage of the new Cineroc™.

While passing through the area, Colorado Governor John Love stopped in Penrose and toured Estes Industries. Before leaving the facilities, he launched a 1/100th scale Saturn V™ rocket.

1970 was one of the best of years for Model Rocket News. Three 12 page issues were published. There was virtually no direct advertising of Estes's products. It was all serious "modroc" stuff. Here's a brief rundown of the important articles appearing in those issues.

### MRN, VOLUME 10 #1

The cover of Volume 10, #1 (Feb '70), featured a dramatic liftoff photo of an Estes Saturn V™ (1/100) that was actually launched in the Houston Astrodome. Notes from the Boss written by Vern Estes gave a full page of coverage to the December 31, 1969 launch. This indoor flight was

made during halftime activities of the Bluebonnet Bowl game. The March '70 issue of "Model Rocketry" magazine had additional coverage and photos. How would you like to do a demo launch in front of 55,200

spectators in the stands and a television audience? A special D engine (15.5 nt.-sec.) was designed by Estes to take the Saturn V™ to within 20 feet of the Astrodome roof. Between halftime bands, the lights were dimmed and the demo began. Launchers had been set up under the goal posts. Each let loose a barrage of six rockets that crisscrossed over the field. The lights came back on and seconds later from the 40 yard line launch pad, the Saturn V™ lifted off for a perfect flight.

A two page article by Bill Simon entitled "Looking Back, the Decade in Model Rocketry" gave an informative review of Estes Industries from 1960 through 1969. The "Idea Box" had a full page of "modroc" tips while Rocket Plans #67 (Blue Lightning) and #69 (Constrictor) took two pages each. Bob Cannon's two page article on the speed of model rockets was titled "How Fast Did It Go?". Finally, on page 12 was "Focus on Shipping", one of a series of articles focusing on different aspects of plant operations. Stacks of antique kits can be seen in two of the five photos.

### MRN, VOLUME 10 #2

The new Cineroc™ movie camera was the big news of the Volume 10 #2 (June '70) issue. The front cover featured Mike Dorfner holding the Cineroc/Omega™ and five frames of spectacular aerial footage. Mike conceived the idea of the Cineroc™ back in 1965. Although the article on page

three contained little new information, the additional photos made up for it.

In 1970, Estes helped sponsor a moon rock show at a National Science Teachers Association meeting in Cincinnati, Ohio. Vern Estes is shown holding a lunar sample in Shutter Briefs, a back cover photo page. "Notes From the Boss" covered Apollo 13 and aero-

*Continued on page 15*

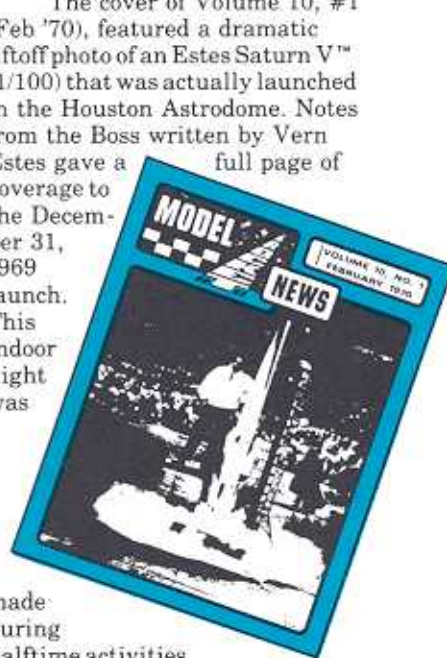

# RUMBLING

## from the pad

### BITS OF PIECES!

Very soon you will notice new bags for all of our bagged kits. These bags have a bright new decor of purple, black and yellow. And by popular request from our customers, the back of the bag will be partially clear and partially printed. The new bags will be phased in over the next year as we deplete the old stock.

The 1993 catalog should be in your hands by now! It has been totally reworked, rewritten and reformatted from the previous years. Kudos to Estes' Visual Graphics and Marketing departments for a job well done!

### GREAT NEW REBATE OFFER!

Estes announces the first promotion off the block for '93. With the "Fly More - Save More" rebate promotion, you can save up to 40% on Estes model rocket products.

Effective February 15, 1993 and running until May 31, 1993, you can send in proofs of purchase

plus sales receipts and a simple rebate form. Then, we send you a check. It's as simple as that! And, you can accumulate separate purchases to reach higher rebate levels - up to 40%!

Last year's rebate offer was a hit, so don't wait to get in on the action. See your local retailer for information on this great spring promotion!

### COMPETITION ENGINES

Attention all competitors who are looking for engines to fly in those 1/4A events. Estes will offer a special competition engine bulk pack. This bulk pack consists of twelve 1/4A3-2T and twelve 1/4A3-4T mini-engines for a total of 24 N.A.R. contest and safety-certified engines (pending certification). In this bulk pack you will also find 30 igniters and, of course, 24 of our patented igniter plugs. The price on the whole pack will be \$29.99 and is available directly from Estes as EST 1779. The 1/4A3-2T is perfect for boost glide or 1/4A

rocket glide, while the 1/4A3-4T is great for 1/4A parachute duration or 1/4A streamer. These engines are also wonderful for small field flying. I would also like to know from competitors out there, if there is any interest in the following mini-engines: A3-0T, A3-2T and the A3-6T. Your input can determine if we should bring these engines out in a similar bulk pack! *Coming Late Spring!*

## some E2X tips

To make certain the rotors of your Estes E2X™ Skywinder™ rotate freely, apply a few squirts of graphite or talcum powder to the hub assembly.

When constructing the E2X™ Bandit™, Dagger™ or Rampage™, you should assemble the shock cord mount and lock without installing the shock cord and then let the glue dry. Then knot one end of the shock cord and pass the free end through the hole in the shock cord mount, pulling the knot tight inside the mount. It seems the plastic glue can damage the elastic in the shock cord, so it is best to let the glue dry before installing the shock cord. We are now providing these instructions with our kits.



Continued from page 5

receive an International SpaceArc Society Kit including a color poster, official certificate of participation, membership card and prepaid SpaceArc form, interested individuals should send a check or money order payable to SpaceArc for \$7.95 for the first kit and \$5.95 for each additional kit (includes postage and handling) to: SpaceArc, 657 East Avenue, P.O. Box 1480, Rochester, NY 14603. Please allow 3-4 weeks for delivery. At the end of the article is a sample of the archive form anyone can use.

SpaceArc is a not-for-profit educational project of the Rochester Museum & Science Center.

## THE TRANSROC II™

Tired of losing your

rockets in high weeds or in faroff places? Have we got the solution for you! Recovery is easy with this compact, lightweight sonic tracking and locating system for model rockets. The on-board unit fits in any BT-20 size or larger rocket and emits a strong locator tone.

The direction and frequency sensitive hand-held receiver will pinpoint the sending unit at up to 183 meters (600 feet) range. This range is dependent upon terrain and wind.

The Transroc II™ includes a headset and magnetic compass. It also requires one 9 volt battery for the receiver and a 6 volt (type 2CR1/3N) battery for the sonic locator device. The Transroc II™ (EST 2237) can be found at your local hobby store and retails for \$29.99.

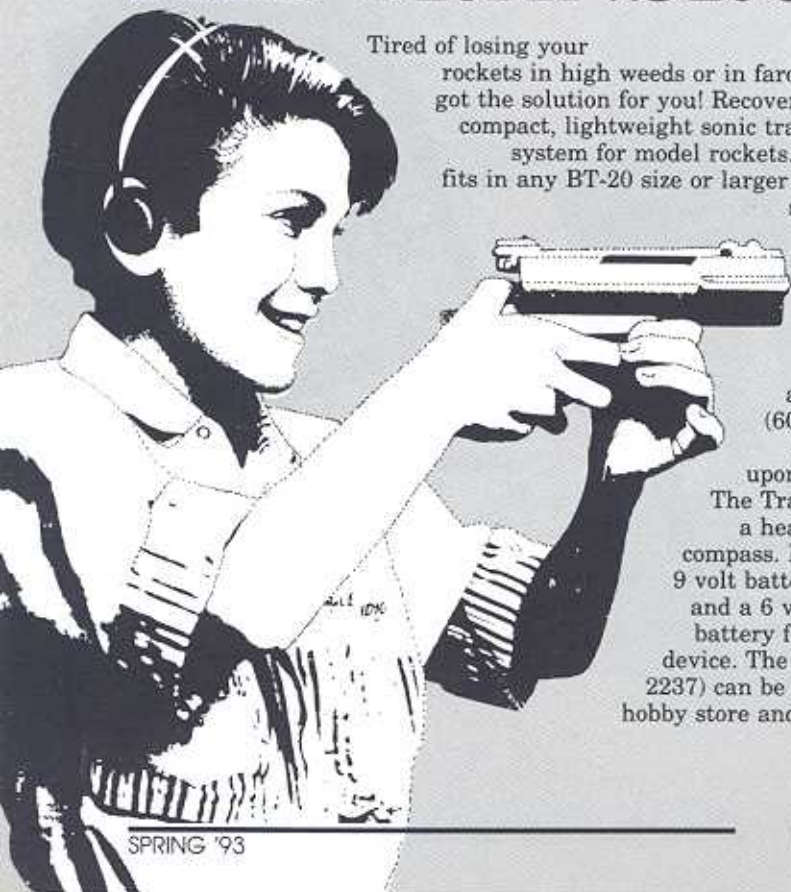



# THE ROCKET PLAN

Plan Number  
**110**

## THE LIZARD

*A pop pod boost-glider for 1/2A to B engines*

*By Bill Dennett, Estes Marketing*

Don't ask about the name, you'll find out later. I'm not big into naming my models, so I'll settle for just about anything. Anyhow, the Lizard is a very easy to build pop pod boost glider that performs well enough to be competitive in B boost glide events. But its real reason for being is as an introduction to boost gliders and winged models in general. I know there are plenty of readers out there who have a few glider recovery models under their belts and will find this a basic project, but there are also many who have never tried one for various reasons.

This model is easy to build, easy to trim for flight, and boosts very straight with 1/2A6-2, A8-3 or B4-4 power. With 1/2A's, flight times easily exceed one minute. With B4-4 engines, it goes way-y-y up there and seems to glide forever. At a recent local contest, the winds were brisk and blew everything downrange at a tremendous rate. The timers lost sight of the Lizard at about 2½ minutes, but at that point, it wasn't even thinking of coming down yet! I finally recovered it about a mile downrange. When used in B boost-glide events, this model reflects the "get it way up there" school of thought vs. the larger models that boost to lower altitudes, but try to make up for it in glide performance. I generally build smaller gliders and believe the higher altitudes achieved give them a better probability of finding

a thermal. I've won a good share of the boost glider events I've ever entered, so I'll probably use that philosophy for a while yet...

So, if you want to give this model a try, dig out your parts box and some balsa wood, and let's go!

## CONSTRUCTION

Start with the pop pod, since it goes quickly. First, cut an 8" length of BT-20 body tube. Mark two lines at one end, 180° apart (i.e. on opposite sides of the tube). Extend each line the full length of the tube, but, before that, sand the gloss off the tube where the lines will go for about 4" from the rear on each side to make the glue joints stronger.

On one line, make marks at 27/8", 2½", 1½" and 1¼" from the end and on the other line, make one mark 3/8" from the rear. Make a small slit at the 2½" mark to accept the engine hook. Next, set the engine hook in place and spread a bead of glue all around the tube between the 1½" and 1¼" marks and slide the engine hook retainer ring into place between those marks. Smooth out any excess glue. While this is drying, work on the standoff.

I used 3/16" x 1/8" spruce strip stock, but hard balsa is okay too. You can buy strips this size at most hobby shops, but if you prefer, you can cut them from a 1/8" sheet. Keep the sides square to avoid misalignment of the pod and/or poor fits. The best way to make parts 1 and 2 is to first cut a piece 3 1/16" long, then make a 45° cut to separate the two parts. Mark the ends that were together before cutting, then cut the other 45° angle at the rear of part 2. This way you can make sure that when the pod is assembled, the two 45° surfaces will fit together perfectly for a slop-free fit. Then, glue part 2 to part 3. While that is drying, cut the two side supports from 1/16" balsa, making sure the grain is vertical as shown on the plans. Glue the side supports to the assembled standoff, making sure to scrape out any excess glue that gets between the supports that could interfere with the fit of the glider.

You will need to cut or sand a little clearance into the top of the standoff to clear the retainer ring. Carefully remove a little material between 7/8" and 1½" from the rear. Remove just enough to allow a good fit between the body tube and the standoff. Next, glue the standoff securely in place on the line opposite the engine hook with the rear

of it even with the 3/8" mark made earlier. Make sure the standoff is accurately centered on the line and stands at 90° to the body tube (same as lining up a fin). The launch lug is then glued to either side of the body tube/standoff joint, even with the rear of the side supports.

Glue a 3/4" long piece of BT-5 body tube into a BT-5/BT-20 adapter ring as shown. This piece of tubing protects the shock cord from direct exposure to the ejection charge. With a piece of scrap wood, apply a bead of glue to the inside of the pop pod body tube about 2¾" from the rear (just forward of the engine hook tab). Then slide the centering ring/BT-5 tube assembly in from the front, with the tube facing forwards, until it butts up to the engine hook. Make sure no glue gets into the engine area.

If you're going to paint the pop pod assembly, do it now before mounting the shock cord. Don't get any paint between the supports where the glider is to fit!

Next, make a slit about 1/4" wide at the 27/8" mark ahead of the engine hook. Feed a piece of 1/8" shock cord through this slit and keep feeding it in until it comes through the front of the pop pod tube. Take that end and tie two or three knots in it, so that when you pull it back it won't pull through the slit. Pull it back through until it is snug against the slit on the inside. Make sure there are no twists in it as it exits the tube, so it will lie flat when pulled forward against the tube. Now, work some wood glue into the slit to keep it closed and prevent the cord from pulling through. This may seem like a strange new way to mount a shock cord, but it has its purpose as you'll see next.

Next, at the front of the body tube where the top lines end, cut a small notch as shown on the plans. Lay the shock cord flat along the body tube and mark it about 1½" from the front of the body tube. Now feed the shock cord through the ring on the nose cone until the mark is even with the ring, then tie it in place there. So why are we doing all this? First, make sure there are no twists in the cord, then fit the nose cone in place with the shock cord in the notch. You will notice that the shock cord is under a little tension. When the nose cone is ejected, it is pulled back along the top of the pop pod and avoids getting tangled up in the glider to ruin the flight (the dreaded "Red Baron" that plagues boost glider

fliers!). Tie a small plastic streamer (about 3/4" x 10-15" is good) to the nose cone ring and you're all set! If you use a leader string on the streamer, make it short, 5-6" at most. More will increase the chance of tangles.

## ON TO THE GLIDER:

If you plan to build a few of these gliders (am I being optimistic?), then it's a good idea to make templates for the main components - wing, vertical and horizontal stabilizers. One way is to photocopy the plans, then cut out these parts leaving about 1/2" border around each. Glue them to a piece of card stock, like a file folder, then carefully cut out each part with a sharp hobby knife. The wing stays in one piece until after it is sanded to shape, so don't cut it in two.

Building goes more quickly if you cut out all the parts first. Make sure the grain direction is as shown on the plans - otherwise it will rain balsa bits the first time you launch! Also, mark center lines on both sides of the wing and horizontal stabilizer using a square or triangle to get the center line at a perfect 90° to the trailing edge.

The fuselage is made from 1/8" x 1/2" strip stock and can be cut to shape with a couple of measurements. You can use hardwood or hard balsa, but I prefer to use balsa. Most hobby shops will have strips this size in stock, but otherwise, you can cut the fuselage from 1/8" thick sheet. Start with a piece 12 1/2" long. Make two marks on the top, 3 1/2" and 6 1/2" from the front. At the rear, make marks 1/4" and 1/16" from the bottom. Make one last mark on the bottom, 1 3/4" from the rear. Join the 6 1/2" mark and the 1/4" mark and cut to taper the top rear of the fuselage. Then join the 1 3/4" and the 1/16" mark to taper the bottom rear of the fuselage where the horizontal stabilizer mounts. See the plans for details on these measurements and cutting.

Now it's time to sand airfoils into the flying surfaces. Don't panic, it's easy... If you really hate this step, then you can get away with just rounding the leading and trailing edges of each part, but your glider will fly much better if you work on the wing airfoil. With practice, you can airfoil the wing in just a few minutes. If you don't have a sanding block, you should! Hobby stores carry them, but a good one can be made from a piece of 2x4, 12" long. Mount a sheet of

180 to 220 grit sandpaper to it with push pins and you're ready.

Here's a technique I've used for some time and it really helps to sand accurate airfoils. Start with the trailing edge of the wing as follows: Set the wing onto the workbench with the trailing edge parallel to, and 1/8" away from, the edge of the bench. Then, sand back and forth as shown in the diagram, checking that you sand evenly from one wing tip to the other. The

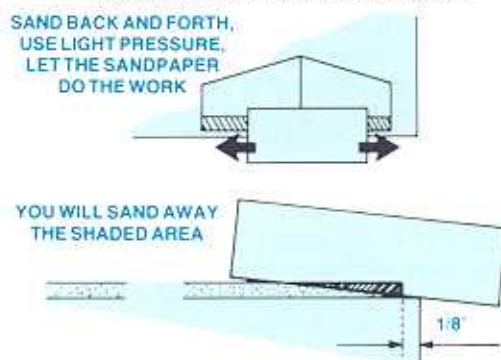

edge of the bench keeps you from cutting too much material away right at the trailing edge. When you have finished, turn the wing around and sand the two leading edges in the same way, but set them 3/16" back from the edge this time. Stop when you have sanded just over halfway through the edge, then turn the wing over and make just a few strokes of the sanding block on the underside of the leading edge. Use a piece of 400 grit sandpaper to carefully smooth and radius the leading edge until it looks like the cross-section on the plans and touch up the trailing edge if necessary. Strive for neatness! The thinner the trailing edge, the better, but if you sand it to a sharp edge it will nick very easily. For contest models I go right to the edge and try to take special care of them. For sport, leave a little thickness for durability.

On the vertical and horizontal stabilizers, just round the leading and trailing edges with 400 grit sandpaper. The horizontal stabilizer will be a little more efficient if it is airfoiled like the wing, but the performance penalty for rounding the edges is very small compared to doing the same to the wing.

It's assembly time. The next step is to add a dihedral angle to the wings for stability. We left the wing together during the sanding step to make sure that the right and left sides were evenly matched. Now, cut the wing in two along the center line. Using the sanding

block, bevel the joining edges of the wing as shown so that they fit perfectly together. This step helps ensure a strong glue joint. Next, glue the wing panels together (use a double gluing method if you are using wood glue: wipe a line of glue on each edge, let it set for a couple of minutes, then apply more glue and join) with one wing tip propped up 2" from the bench and the other wing flat. Let this dry thoroughly. When dry, sand a small flat on the underside of the wing joint as

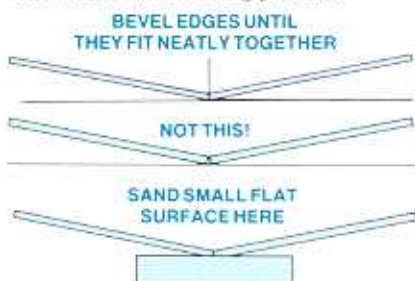

shown, so it fits well to the top of the fuselage.

Glue the mounting hook (part one) to the top of the fuselage, even with the front. A good way to ensure alignment is to set the parts down flat on a piece of wax paper while the glue dries. When dry, sand the nose into the rounded shape shown on the plans.

Next, glue the horizontal stabilizer onto the fuselage with the trailing edge overhanging the rear of the fuselage by 1/4". Make sure it is centered accurately, and the fuselage sits at 90°. When dry, set the fuselage down on the workbench, securing it in place with a couple of strips of tape at the front and rear. Make sure the horizontal stabilizer is parallel to the bench. Glue the wing into place with the front of the wing even with the 3 1/2" mark made earlier and prop the tips up so they are equal heights from the bench. Allow to dry, then reinforce the wing and horizontal stabilizer to fuselage joints with an extra fillet of glue.

Glue the vertical stabilizer to the underside of the horizontal stabilizer making sure it is at a 90° to it and aligned with the center line accurately. Allow to dry.

Almost done! Check the fit of the glider into the pop pod - it will probably be a little tight. The fit you will try to achieve will be what I call a close, but not snug, fit. When you hold the pop pod nose down, the glider should fall out easily, but there should be as little slop in the fit as possible. Use the sanding block very carefully to

POP POD - SIDE VIEW - 3/4 SCALE

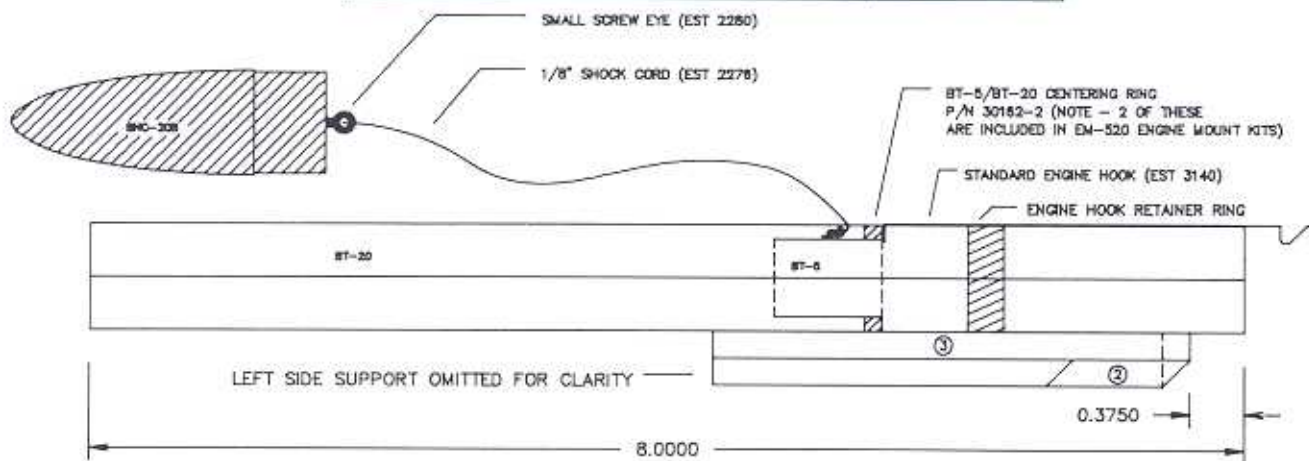

REAR VIEW



SIDE SUPPORT - 3/4 SCALE

TWO PIECES REQUIRED - MAKE FROM 1/16" Balsa. GRAIN DIRECTION IS IMPORTANT

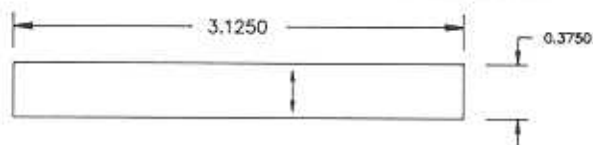

STANDOFF ASSEMBLY

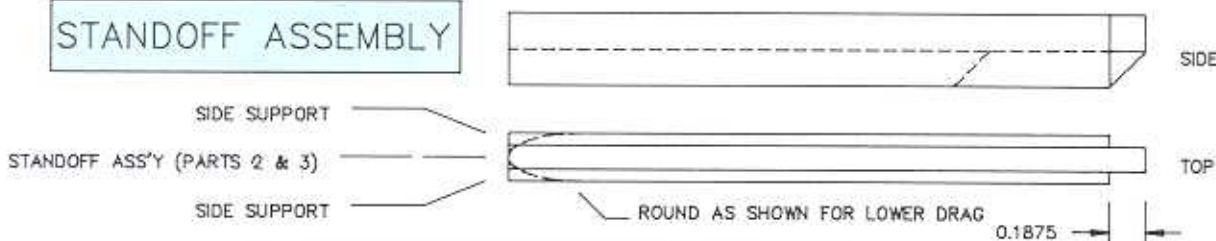

BODY TUBE MARKING GUIDE - TOP SIDE

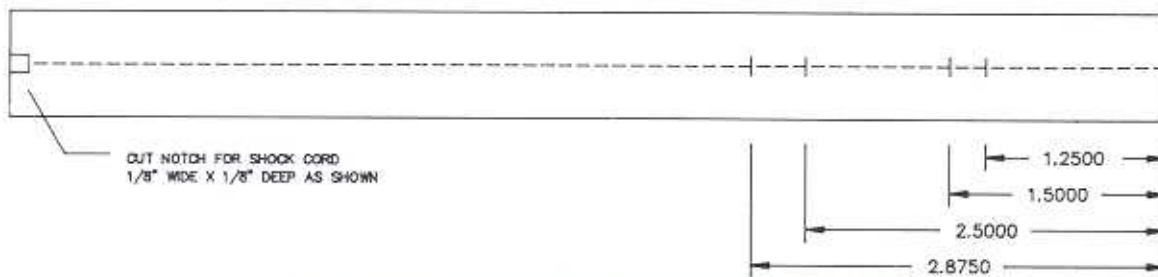

BODY TUBE MARKING GUIDE - BOTTOM SIDE

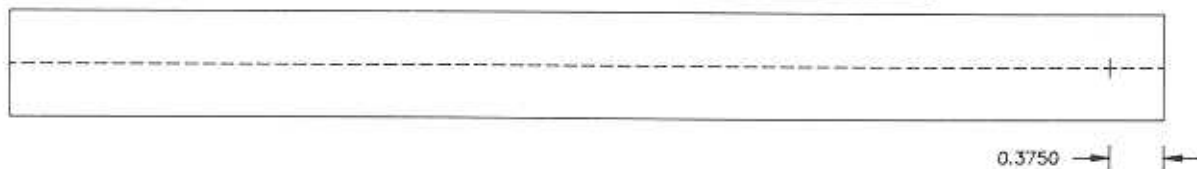

SANDING BLOCK

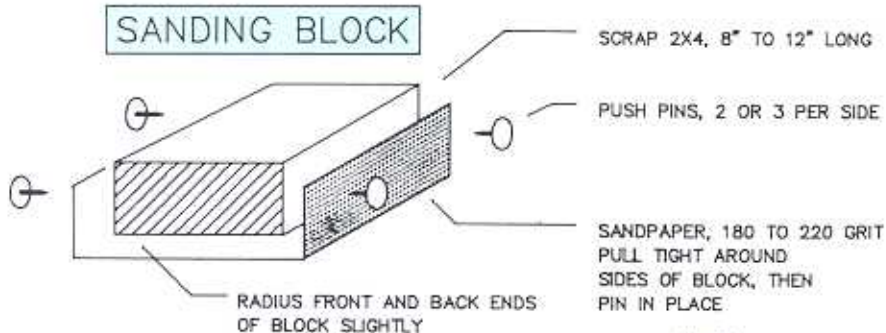

Lizard	- a basic boost glider for 1/2A to B regular engines
Pop pod details	
Scale: As Shown	01/06/93
DRAWN BY: <i>Bill Dennett</i>	

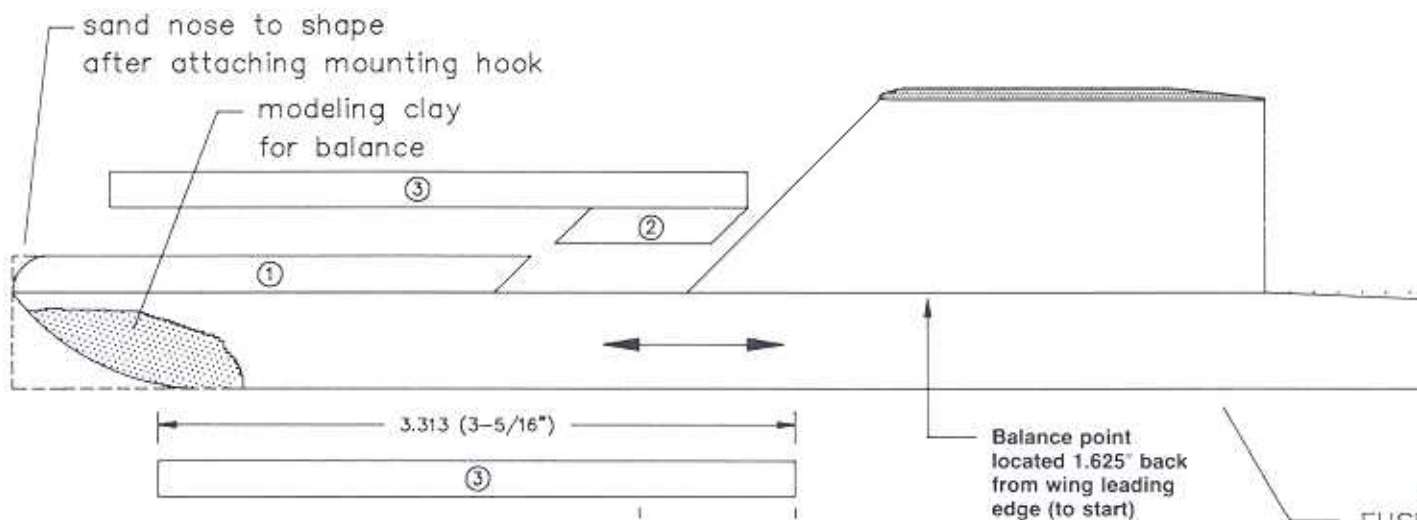

CUT FROM 1/8" X 3/16" HARDWOOD OR HARD BALS

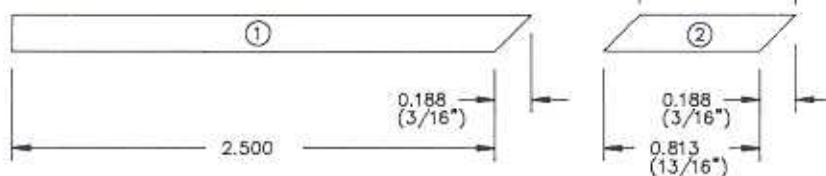

Mounting hook detail

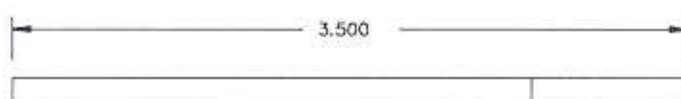

WING DETAIL:  
Start by cutting a 10" piece of stock from a 3" wide sheet. Then mark and cut as shown.

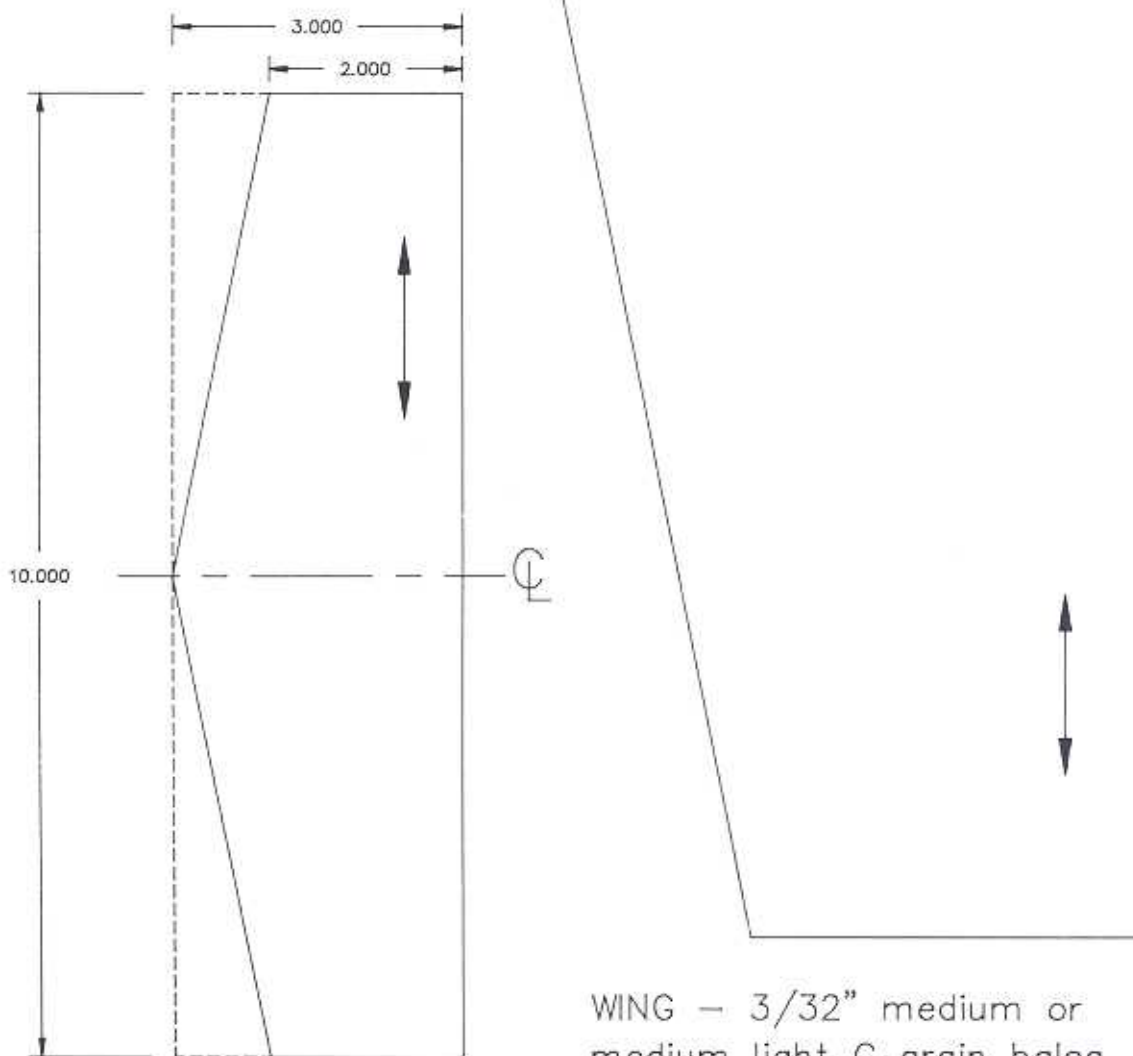

NOTE  
vertic  
made  
durab

Marking and cutting details for fuselage rear

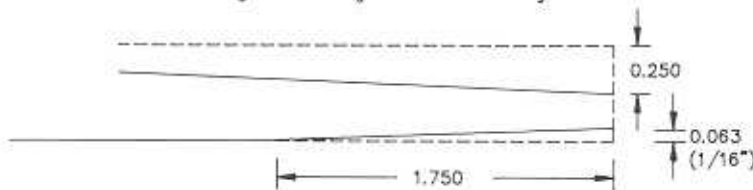

VERTICAL AND HORIZONTAL STABILIZERS –  
1/16" medium C grain balsa

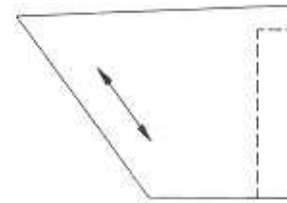

dotted line shows rudder tab, if used

FUSELAGE  
1/2" x 1/2" hard A grain balsa  
Pine or basswood also suitable

ALL DIMENSIONS SHOWN  
IN INCHES.

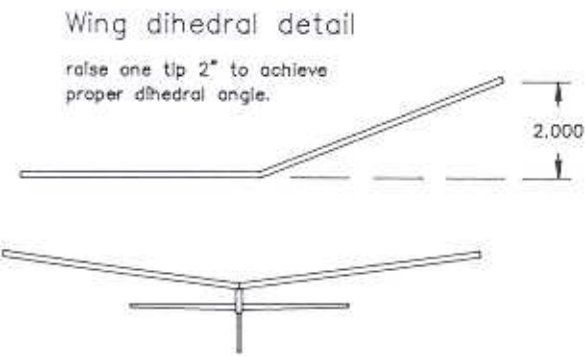

Wing dihedral detail

raise one tip 2" to achieve proper dihedral angle.

2.000

FRONT VIEW  
1/4 scale

Wing airfoil – 1.5x actual size  
"close is okay!"

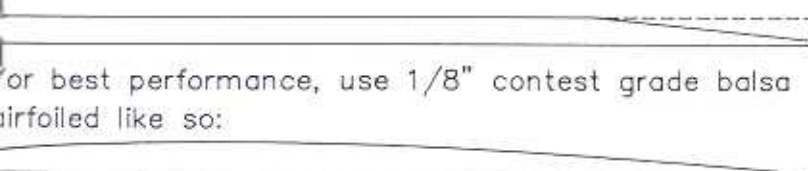

For best performance, use 1/8" contest grade balsa  
airfoiled like so:

Note: all parts are shown actual size on this drawing. Wing, fuselage, vertical and horizontal stabilizers, and mounting hook patterns may be made by photocopying these plans and cutting out the templates. For durability, glue the templates to card stock before cutting them out.



wood grain direction denoted by directional arrow

Lizard		- a basic boost glider for 1/2A to B regular engines
Wingspan:	10.0"	
Length:	12.75"	
Wing Area:	25.0 in <sup>2</sup>	
Scale:	1" = 1"	01/06/93
DRAWN BY:		Bill Dennett

sand the side of the fuselage and mounting hook until the fit is just right. Now is the time for finishing and decorating the glider if you wish. Colored paints are heavy so I avoid them. An excellent way to make a lightweight, highly visible finish on glider models is as follows: use fluorescent highlighter markers to create a bright color scheme of your own design and use a black marker to add some dark areas on the underside of the wing for contrast in the air. Have fun, be creative! It is important to be able to see your glider both in the air and on the ground, so use a combination of dark and bright colors. Next, spray a couple of light coats of clear paint over the entire glider. When dry, lightly sand away the "fuzz" on the balsa surfaces with 600 grit sandpaper. The markers soak into the surface deep enough that your artwork shouldn't be affected. Recheck the glider to pop pod fit and you're done! Phew!

## BALANCING

The glider must be balanced properly fore and aft for proper flight. Make a mark on the underside of the wing on both sides close to the fuselage and 1 5/8" back from the leading edge. Add modeling clay to the front of the fuselage until the glider balances level at the two marks, resting on your fingertips or a couple of pencil points. Smooth the clay into place,

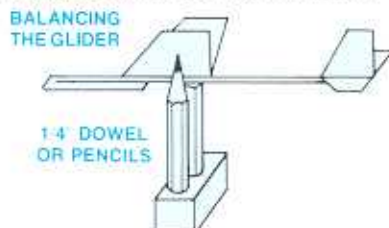

but don't get anywhere where the pop pod fits.

## TRIMMING FOR FLIGHT

It's time to find out if your creation flies (of course it will!). If it's windy, forget it, wait until it's fairly calm outside. Give the glider a firm push forward, aiming at a point on the ground about 30-40 feet ahead of you. Don't toss it upwards! The idea is to give a smooth forward launch at its normal gliding speed and attitude with a clean release (and without hitting the vertical stabilizer on your hand as you let go). Launch it a few times to get the hang of it before you make any decisions and observe the flight closely.

If luck is with you (ever notice how the better the job you do, the luckier you get?) the glider should glide smoothly out and land about 25 to 40 feet away, perhaps with a slight turn. Great! Otherwise, compare the flight to the diagram. If it pitches up sharply

**TAIL HEAVY -  
ADD NOSE WEIGHT**



**NOSE HEAVY -  
REMOVE NOSE WEIGHT**



**YOU'RE SET  
FOR LAUNCH**



and/or descends in a series of swoops and dives, it's tail heavy - add a little more weight to the nose and try again. If it nose-dives for the ground, remove a little weight and try again. If it flies smoothly ahead but doesn't fly too far, it still could be nose heavy, so experiment by removing a little weight.

You want the glider to turn in flight, otherwise it will land a long, long distance away. I have found that, in general, even if you line things up as perfectly as you can, that most gliders have a natural tendency to turn one way or the other. If the glider shows a gentle turn to one side, that's great, leave it. Otherwise, you will need to tweak the rudder (rear of the vertical stabilizer) a little to the side to achieve a turn. On the plans I've shown a rudder tab-cut through the horizontal line and cut partway through the vertical line. Bend this tab a little bit to either side (about 1/32"-1/16" is enough) and launch again. A turn radius of 40-100 feet is good. You might notice that the glider tends to dive a little more when you add rudder tab. This is normal and is caused by the loss of lift of the wings when they bank (tilt) to one side. If so, remove a little weight and try again. It will all make sense after a few tosses, don't worry!

If you used the rudder tab, rub a little glue into the cut lines once you have found the setting you want, to hold it in place.

## LAUNCHING

Finally - it's time for the fun stuff! Use 1/2A6-2 engines for the first flights. To prep the model for flight, first crumple and insert two or three squares of recovery wad-

ding into the pop pod, then roll and pack the streamer. When you insert the nose cone, make sure there are no twists in the shock cord and that it lays flat against the body tube. Mount the engine and install an igniter with the igniter leads bent to the side and facing away from the glider.

You will need to wrap a couple of turns of masking tape around the launch rod high enough so that the glider just clears the blast deflector (see diagram). When

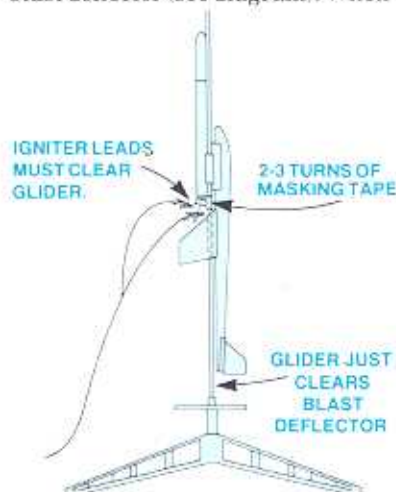

you attach the ignition leads, make absolutely, positively sure that they extend away from the glider and will not interfere with any part of it on the trip up the launch rod. Otherwise, some vital part of the glider is going to stay behind and spoil your day. In the "old days" before Estes igniter plugs, glider models were notorious for pulling igniters out before launch because the leads were pulling down and sideways on them. Now, in the "new days", this isn't a problem - igniter plugs don't fall out like that. Some modelers stick an extra launch rod in the ground about a foot away and tie the ignition leads off to provide strain relief.

On your test flights, always launch straight up and in calm weather. Before you "let 'er rip", make sure the glider is nestled squarely in the pop pod mount one last time. Then put in the safety key, count down and launch.

Here's what should happen: the model should fly straight up like any "normal" model rocket. At ejection, the nose cone should snap back along the body tube and the streamer should unfurl while the glider separates, bleeds off any excess speed and settles into a glide. Keep track of where the pop pod lands (friends are handy for this, but if they watch the glider,

they may miss it). Watch the glider flight closely (I need to tell you this? Of course you're watching it!) and note if it behaves in any peculiar ways. Hopefully it will descend in nice, lazy circles. You can expect flights of anywhere from 20 seconds to over a minute on 1/2A's. If it spirals tightly to the ground, you probably added too much rudder tab. Readjust and try again. If it doesn't turn at all, start running! The test glide chart tells you what to do otherwise.

When you are happy with the test flights, try an A8-3 for more altitude and longer flights. Unless it's really calm, I don't recommend B4-4's for sport flights because it easily flies for four minutes or more and will drift a long-g-g way! C's are out of the question (you'll never see it), and may peel the wings off. Oh, and it won't fly with anything but an Estes engine, so don't try!

If you want to build a real performer, use 1/8" contest grade (light!) balsa for the wings and really work on the airfoil. Use light or medium light 1/16" for the stabilizers, contest grade may not stand the stress of boost. Anyone who reads the model airplane magazines will see occasional references to hand launch glider competitors - these guys **know** how to build balsa gliders and you can learn a lot from them!

That's it. I hope you give this model a try. I don't claim it's the most amazing boost glider in the world, but rather that it is simple, and that you can learn from it. It's a good sport model and a good qualifier or competitor in local model rocket contests. Have fun - that's what it's all about! Glide recovery model rockets are a whole new dimension for those that haven't tried them!

Oh yeah - the name. When I built the prototypes, I couldn't find any BT-20 tubing or nose cones in my parts collection. But I had a couple of Estes Wizard™ kits. So, I robbed everything but the fins to build the pop pods. I thought the decals would look good on the wing, but I couldn't steal the name, so I cut off the "W" and drew in an "L". I thought it was a better name than Gizard or Blizard. Don't you agree?

## FOOTPRINTS on the MOON

Continued  
from page 7

space vacation suggestions with a special invitation to Estes Industries. Included in the MRN also were kit plan #71 (Black Knight), the "Idea Box", another article by Bob Cannon ("Acceleration Against Gravity"), 13-year old Scott Cutcliffe's article on meeting Neil Armstrong and coverage of the re-entry of Explorer 1. And could this be the first appearance of the Rocketus Eatumopus, the rocket-eating tree (submitted by Peter Chodakowski)?

### MRN, VOLUME 10 #3

This issue is possibly one of the rarest ever printed. It was distributed mainly to contestants of NARAM 12 and dated August 1970. The next issue of MRN (Vol. 11 #1, January '71) contains seven pages of duplicate material.

MRN's cover story was "Estes Electronics go to Yugoslavia" (to assist in the Model Rocket World Championships in Vrsac). Pictured on the cover are Estes electronics technician Mack Eppler and Earl Estes (Vern's brother), Director of Estes' Electronics Laboratory. Estes Industries was asked by World Championship officials to supply special test equipment to check the contestants' engines to assure that they all met F.A.I.



standards.

The company developed the Estes Semiautomatic Portable Engine Test System (ESPETS) capable of testing engines manufactured from all participating countries. "Notes From the Boss" devoted a page to the use and design of ESPETS at the World Championships and NARAM 12.

Larry Renger wrote an article on "Careful Preparation of Your Rocket can Eliminate Bad Luck in Contests" and this issue introduced readers to two future kits, the Sandhawk™ and the famous Interceptor™. The "Idea Box", a "Name the Estes Rocket" Puzzle, Technical Note 2 on "Engines Performance" by Edwin Brown and two kit plans (Larry Renger's "Rear Ejection Sprint" and Estes kit plan #72 Kamikaze Baka) rounded out this issue.

A special thank you goes to Dr. Bob Kreutz of Bricktown, NJ for his invaluable assistance by providing me with a photocopy of MRN Vol. 10 #3.

## CONTRAILS

Edited by Mike Hellmund



ECRM-10 - June 5-6th, 1993; Middleton, MD; Host Club: NARHAMS; Events: Sport Scale, B Helicopter, B Rocket Glide, D Dual Eggloft Duration, A Payload, 1/2A Cluster Altitude.

For more information, contact:

Tom Lyons,  
P.O. Box 1746,  
Prince Frederick, MD, 20678,  
Telephone: (301) 855-9457.

NARAM 35 - National Association of Rocketry's national contest and sport launch; August 1-7th, 1993; Middleton, MD; Host club: NARHAMS; Events: A Streamer, B Helicopter, B Super Roc Duration, D Super Roc Altitude, R & D, Sport Scale, A Rocket Glider, B Boost Glider, D Eggloft Duration and E Dual Eggloft Altitude. There will be a sport launch. FAA waiver has been requested. Spectators welcome!

For more information, contact:

Tom Lyons,  
P.O. Box 1746,  
Prince Frederick, MD, 20678,  
Telephone: (301) 855-9457.

Pact III (Philadelphia Area Convention & Trails); April 23-25, 1993; Host Club - PARA; Events: Seminars, Discussions, fun flights and record trials (for U.S. altitude and duration records). For more information, contact: Steve Decker, 410 W. Palmer Avenue, Morrisville, PA 19067-2172, Telephone: (215) 736-8947.

# Command Control™

## Launch Controller

- **Ultimate Power for Advanced Model Rocket Launches**
- **Multiple Power Source Options**  
Power from Internal Nicad or External 12-Volt Battery Source  
(Batteries Not Included)
- **30 Feet of Heavy Gauge Strand Wire**



**F**or those of you who own a Command Control™, I thought I'd pass on a few items of note:

- 1) There is no need to alter the internal circuitry, circuit board or wiring. Don't do it! It will void your product warranty and may create a safety problem.
- 2) Never apply more than 18 volts of DC to the Command Control™.
- 3) The two external charge jacks are not designed for high current "fast" chargers. If you have a "fast" charger and want to use it, you will have to remove the batteries from the controller before doing so to prevent damage to the circuitry.

If you wish to power your Command Control™ by something other than the 7.2 volt NiCads, here is the way you do it:

- 1) First, never connect a high capacity external battery to the Command Control™ while the internal batteries are in place.
- 2) Do not connect a battery through the 5 mm charge jacks. The wiring and circuitry won't withstand the current.
- 3) To connect an external battery, use the same type plastic Tamiya connector used in the controller. You will need a



- 4) female plastic connector and male pins. You should be able to find these sold as sets at hobby shops.
- 4) Get about 10 feet of 18 gauge twin lead zipcord (or lamp cord). Crimp and solder the two male pins to one end of the zipcord.
- 5) Insert the pins into the plastic connector body until they snap in place. Keep track of the battery polarity. The pin in the square opening will be positive and the pin in the semi-circular opening will be negative.
- 6) Now you need to decide what the connections will be on your external battery. If you are going to hook up to a car battery, the connections should be made through the cigarette lighter. Avoid connecting battery leads directly to the car battery. You can get a cigarette lighter plug at any electronics parts store. If you are going to hook up to a gel cell or other type battery, you may wish to use battery clips. Make sure you get a red marked clip and a black marked clip.
- 7) Now make sure you have the correct polarity. Trace the wire connected to the pin in the square opening to the other end of the wire. Hook either a red marked battery clip or the center connection on the cigarette lighter plug to this wire. This will be the positive (+) connection.
- 8) Hook the other wire to the black marked clip or to the outside or rim connection of the cigarette plug. This will be your negative (-) connection. Double check the connectors to insure that the polarities are correct.
- 9) This cable is connected to the #1 battery connector inside the Command Control™.
- 10) Switch the Command Control™ to the 7.2V position for external battery use.
- 11) If you use battery clips, you will have to make sure that you connect the external battery correctly - red to positive, black to negative.

Well, that should do it! I'd like to thank our R&D Department for this information on the Command Control™ launch controller.



# Quick Tech

## #3 Using INSTANT GLUES

By Mike Hellmund

Tired of waiting for white glue to dry? Not even patient enough for yellow glue or even five minute epoxy? You have undoubtedly heard of instant glue, a.k.a. CA, or as it is more correctly known, by its official name of cyanoacrylate glue. By taking a few precautions, this is perhaps the quickest, neatest and, with the possible exception of hobby grade epoxy, the strongest glue to use on your rockets.

First, the precautions, better yet, requirements, for the use of CA

- 1) If you're under the age of sixteen, we strongly recommend you have an adult assist you, as CA can be dangerous.
- 2) Make sure your work area is extremely well ventilated. CA's fumes can be very irritating.
- 3) Wear rubber gloves, such as surgical gloves. This type of glove can be found at most hardware stores. One size usually fits all. Don't use kitchen latex gloves, they are cumbersome to use when modeling. When CA manufacturers say that their glue bonds quickly, they are not kidding. Rubber gloves give you that extra insurance that you won't bond your finger to the tip of your nose.
- 4) Instant glue does not adhere (or at least very poorly) to wax paper. This makes wax paper a great covering for your work surface. Remember CA will adhere to almost anything else. There's nothing more frustrating than gluing a fin to your workbench in less than thirty seconds.
- 5) This is one of the most important requirements. The author speaks from experience - a very lucky experience. While trying

to unclog a CA bottle, I had a small amount of CA squirt into my eyes. The result: one ruined contact lens and a slight chemical burn on my cornea. I was extremely lucky. The CA could have missed my contact lens. I could have lost an eye. You may not be so lucky, so be warned! Moral of this story: wear safety glasses, always. Let me re-emphasize: ALWAYS WEAR SAFETY GLASSES.

### THE SUPPLIES

The proper CA to use is called professional grade and is the type usually found at hobby stores. The kind that you can purchase at department and hardware stores does not possess the high quality you need for model rocket application. This type, usually found in small toothpaste-type tubes, quickly becomes brittle with age.

At your hobby store you'll find several grades of glue - a fast or thin grade, medium viscosity and slow or thick viscosity. The slow grades are sometimes referred to as "gap filling" because they are so thick that these glues can literally fill in small holes and cracks without running. This is an important characteristic for a lot of model rocket applications. To get the maximum benefits, get a bottle of each viscosity. The thicker the CA, the stronger the bond it will create. You will also want to get some application tips (fine and extra fine). These tips will allow you to control the application of the glue. They are also important for another reason - CA has a habit of clogging at the tips. Since the application tips are disposable, it is better to have them clog than have the tip on the bottle clog. You should probably get a dozen tips. Another important item to add to your instant glue "tool chest" is accelerator, sometimes called "kicker". This handy spray will allow CA to bond instantly (and I mean instantly!) Contrary to popular belief, with the exception of the thin grade CA, instant glue does not bond instantly. With the slow CA, it can take up to 45 seconds to bond. That's a long time to keep a part such as a fin or launch lug in position. The accelerator will cut that time down to almost zip. The last item you should have is debonder. It does exactly what it says - it will debond instant glue. This is great, if for some ill-conceived reason you didn't wear your gloves. It will unstick your fingers. It has other important uses that we will

mention later. So, to recap, the items you need for your instant glue tool chest:

- One bottle of thin grade CA
- One bottle of medium grade CA
- One bottle of thick grade CA
- 6 to 12 tips (extra fine and fine)
- One bottle of accelerator
- One bottle of debonder

Let me at this point advise you that using CA can have substantial impact on your building budget. These glues are not cheap, however, they go a long way. Three one oz. bottles, plus application tips, accelerator and debonder can cost you as much as 35 dollars. Now that is sufficient glue for over a dozen models. Only buy as much glue as you would need in about a six month period of time. CA will lose its effectiveness over time, however, to extend the life of an unopened bottle of glue, you can store it in your refrigerator (just make sure that no one in your family decides to use it as a flavor enhancer). Once you become comfortable with using instant glue, it is doubtful you'll use anything else (with the exception of epoxy). It will allow you to build a rocket quickly, neatly and strongly.

### USE

To best illustrate how and which grade of CA to use, let's go through some of the main steps of a basic kit.

- 1) The first step, after you have read the instructions and taken all of the above outlined precautions, is usually the engine mount assembly. After you have positioned the centering rings, use the thin CA (with the fine applicator) and gently allow a few drops (you should NOT have to squirt or force it out) to soak in the joint of the engine tube and centering ring. This should bond instantly. The thin CA will help you position the centering ring, freezing it in position. If not, spray some accelerator on the joint. Now is a good time to go over some pointers on using accelerators:
  - A) You should always spray away from your building area, away from the open bottles of CA. If even a whiff of the accelerator gets near the tips on the CA, it will clog them.
  - B) Too much accelerator (coupled with too much CA) will cause the CA to "foam" and it will generate an immense amount of heat. The thicker CA is less likely to foam. It's best to

spray the accelerator into the air and then move the pieces through the mist. If this method won't work for a particular application, then spray from about 18 inches away. Use the accelerator sparingly, too much of it will "linger" around the bonded pieces, causing any further applications of CA to bond quickly - perhaps before you have the pieces in their proper positions.

C) When using the medium or thick CA, which usually won't bond instantly, it sometimes helps to spray accelerator on one of the pieces to be bonded and the glue on the other piece. Then hold the two items together. The bond should be instant.

D) Some plastics and most painted surfaces do not take well to accelerator. Test the material before you use accelerator.

E) Try to use accelerator that is made by the same manufacturer as the CA.

F) Try not to get accelerator on your gloves. Because of the "lingering" effect of accelerator, it may remain active for several minutes. It will instantly bond your glove fingers together if you get CA on them.

Back to the engine mount...

After you have allowed the thin CA to soak in, fillet the joint with medium CA. Use the accelerator to cure the fillet. When gluing pieces together that will not fall off the moment you let go (such as the engine hook retainer ring), use the medium or even thicker CA right from the start, skipping the thin CA step.

- 2) Use the thicker CA to glue the engine mount into the body tube. As long as you didn't use too much accelerator in assembling the engine mount (the "lingering" effect), the thick CA should give you enough time to slide the mount in the tube. Nevertheless, you should make sure the engine mount is in the proper position the first time you slide it in. The likelihood is you won't get a second chance. Once the mount is in place, use the medium grade to fillet around and between the bottom engine centering ring and the body tube. Use accelerator if necessary (spray down into the tube and around the bottom centering ring).

- 3) It is with the attachment of fins that the benefits of instant glue shine. First of all, balsa (and paper products) will absorb the thin instant glue. This makes it great to strengthen balsa nose cones, the edges of fins, etc. Simply allow DROPS of the thin CA to soak into the area you want to strengthen. It is not recommended to use accelerator for this application. Soak all edges of the fins. Lightly sand the body tube and make your guide markings. Place a mark on each line where the top corner root edge of each fin is to be located. There are several schools of thought when it comes to attaching fins to body tubes. The method here will work for most A through D engine rockets. Apply several drops (or a thin bead) of medium CA and three or four drops of thick CA along the root edge of the fin. Now, attach the fin, placing the top corner of the fin on the mark and placing the rest of the root edge on the guide line. Sight the fin to make sure it's in position. If you are satisfied, wipe excess glue gently away and spray accelerator directly (from about 12 to 18 inches away) on the joint. Hold until the bond is cured. Go to the next fin. After all fins are attached, check the positioning. You should still be able to remove a fin if you need with some firm, but careful force. If the fins look right, then soak the joint with thin CA. Apply CA on the joint and let the drops roll down and soak into the joint. Do this several times. This will fillet the joint. You should have a crisp even joint. What is also nice about CA is that you sand it if necessary. Sand the joint if it is not to your liking. If your rocket is a sport model, then this joint should serve you nicely. If you need a stronger joint or a more aerodynamic fillet, apply a medium CA fillet or a fillet of five minute epoxy (rubbed smooth with a finger dipped in rubbing alcohol). Try not to use accelerator, it could give you a rough surface that you would have to sand. For an even stronger joint (for D and E powered rockets), use less medium and more thick CA when attaching the fin and the epoxy fillet. Use the thick CA to fill in any gaps in the joint.

- 4) Use medium CA and accelerator to attach the launch lug. Use thin CA to strengthen the joint.
- 5) **Do not use CA** to attach the shock cord to the body tube. CA will attack rubber or elastic cord, weakening it and making it brittle. Assemble the shock cord mount with yellow carpenter's glue. This will give you the strongest, most effective mount.

For model rocket construction, here are some other uses of instant glue and the proper grade to use:

- Attaching screw eyes - medium grade
- Attaching stage couplers, nose blocks and balsa adapters - thick CA with accelerator
- Strengthening body tubes - A lot of old timers (like me) use the thin glue to soak the edges of body tubes. This seals and strengthens them. Make sure you don't insert the nose cone until the glue is completely dry. The thin CA is also great for sealing the edges of fiber fins.
- Debonding - If there is a surface that you do not want to be bonded with CA, then dip a fine paint brush in the debonder and "paint" the areas you do not want to glue.

On the flying field, CA allows you to do quick and easy repairs. Keep medium grade and accelerator in your range box (in a zip-top baggy to prevent spills, etc.). The best way to attach a broken fin is to apply a bead of CA to one broken piece and spray accelerator on the other piece. Hold together until bonded. Remember the accelerator may attack the paint.

Although there are special instant glues formulated for plastics, they sometimes work too fast. Practice to get a feel for their bonding time.

Sometimes the caps that come with the CA bottles don't snap back on very well. I have had success with dipping a pin in debonder and using the pin to seal the cap.

In future issues of the MRN, you will see more tips on how CA can be used in model rocketry. Watch the QuickTech column for other modelers' tips on the use of instant glue. We will also, in the future, cover the use of epoxy in model rocketry. If you have any questions about CA or have other topics of model rocketry construction that you wish us to cover with the MRN, please drop us a line.

## "E" Engines

Continued from page 2

and an E engine hook. Just build those kits strong, use epoxy and/or super glue. If you want to make your rockets convertible for D's or E's, simply take a spent D engine casing and cut off 3/4" from the end. This will serve as a spacer (don't glue it in) for an E engine mount, ahead of the D engine. Both the Pro™ Series Jayhawk™ and Terrier/Sandhawk™ will come with a spacer.

These fantastic engines will be available in an economical two pack (plus Estes igniters and igniter plugs). The suggested retail price is \$7.69 for the pack and they are available at any of the thousands of fine hobby stores that carry Estes rockets.

There you have it. Try them and experience their versatility and the downright "Flugvergnügen" (sorry, but I couldn't resist). You will be very pleased with the Estes E15. Finally an E engine that is a step up, a step away from the D's - an engine suited for that next step for your model rocket experience, an engine that you can use in confidence because it has the Estes logo on it.

Is this all the engines we will develop? Not on your life! Here at Estes our engine development will never rest - we're having too much fun!



Estes' own Tim Van Milligan (R&D Engineer) with a 4 "D" (or "E") engine-clustered Patriot™

# All American ALPHA Final Flights

When we left the AAA, it was headed back to Art Nestor for inspection and possible repairs. Two fins showed a weakened joint, so Art broke the fins off, sanded the body down to the cardboard, reattached the fins and repainted the model (except the nose cone which still sports the original finish). New decals were also applied. What surprised me on this model is that the shock cord was one of those rubber band types and had never been replaced. I'm still shaking my head in amazement. After Art performed the necessary surgery and face lift, the rocket headed to Estes' record Design of the Month winner Dean Pilato in Michigan. Dean was impressed with all the memorabilia that came with the AAA. (I must admit, so was I when I got to see it at flight #51.) Dean had no problems in flying the Alpha® and packed it off to South Dakota. Nathan Edwards took possession of the AAA and decided to go for a double. He flew it in South AND North Dakota. The South Dakota flight took place on the first anniversary of the AAA, July 4th, 1992. The North Dakota flight took place in Ellendale, ND on July 10th. Both flights were successful. Flight #42 was flown by Juleen Berg of Glenwood, Minnesota. The All American Alpha then headed for the Sooner state of Oklahoma where Ron Dunn flew a successful Flight #43. Ron is one of the rocket modelers who enjoys flying low power and high power rocketry. Kent Skelton (whoa, wait a minute - Kent Skelton? Where have I seen that name before? - as I ruffle through the list, ah, here it is - flight #18 for Missouri - the lucky fellow gets to fly it twice!) took the "Alpha Trek" to the home state of our new president - Arkansas. On August 16th, with Kent's nine-year-old son, Matthew, doing the honors,

flight #44 was put into the record books. The "Triple A" headed for William McNulty's house in (now this is spooky - "Twilight Zone" music, please) Clinton, IA. I'm not making this up, folks. William put the All American Alpha up for the 45th time - a success, of course. The AAA then headed to the flying field of Paul Vandall in Rhode Island, home of quahogs, jonny cakes, grinders and coffee cabinets (at least that's what Paul tells me). Paul has been flying in the same field since 1960, when he launched his first rocket, an Estes Astron Scout™ (Estes' first kit). Paul (NAR #21208) had the fortune to belong to one of the most prestigious NAR sections in model rocketry history - the section of the Massachusetts Institute of Technology. I do not think this club is in existence any longer, but they contributed quite a bit to the field of model rocket aerodynamics. The flight in Rhode Island was a success and then the Alpha® headed for South Hero, Vermont for flight #47. There, Bret Corbin did the honors on September 5th. Flight #48 took place in our nation's capital at Bolling Air Force Base on the 13th of September. The flight was conducted by Jay Beigel and his son, Matthew. Now the All American Alpha was headed down the home stretch.

The next flight was conducted by Evona Young (the second woman to launch the Alpha® - all right!). She and her husband successfully launched the Alpha® at the Diamond Pranch, a horse rental ranch owned by Ocile and Martin Portmane just outside Yellowstone National Park. These folks, through the efforts of Evona, got their first exposure to model rocketry. Needless to say, flight #49 was also a success. Before the All American Alpha headed to Hawaii for flight #50, it stopped off in Alamogordo, NM to be presented to Dr. J. Edson Way, Executive Director of the International Space Hall of Fame. Art will donate the rocket, on an indefinite loan basis, to the museum. This is a great place for it to be displayed. The All American Alpha then headed for Hawaii to be flown by Michael Masuda on October 8th. The Alpha® then headed to its place of origin, the birthplace of all fine model rockets, Penrose, Colorado and Estes Industries. This is where the final flight took place. Vern Estes will give the details of the last flight.

# Final Flight of the All American

# ALPHA

By Vernon Estes Photos by Mike Hellmund

There was a sense of special importance as the countdown proceeded for the final launch of the All American Alpha (AAA). We all knew the small red, white and blue rocket had made its journey to 50 other launch sites including Alaska, Hawaii and the District of Columbia. Now was the time for its final reach into the sky and we wanted it to be a very special event.

I was pleased that Art Nestor has asked me to conduct the final launch, and, as he had suggested, the launch was scheduled to take place at the Estes plant in Penrose, Colorado. Working with Estes' Marketing Director, Mary Roberts, arrangements were made for the launch to take place on November 5, 1992 at 3:30 PM. We would use the Estes R&D launch facilities know as Cape Estes. It was particularly fitting that the AAA's 51st and final flight should take place in Penrose where the Alpha<sup>®</sup> was developed and manufactured.

Two days before the scheduled launch, the weatherman assured us of a beautiful, sunny Colorado autumn afternoon. You will understand later why I think he should get a new job.

Barry Tunick, President and General Manager of Estes, as well as many department managers and other personnel, were on hand to participate. Also present was a special Guest of Honor, Meerraine Cannon, whose husband, Robert L. Cannon (deceased), had worked with Art to get the All American Alpha project started.

Gleda (Mrs. Estes) and I arrived at approximately 3:00 PM to find launch site preparations completed. Running slightly



Meerraine Cannon



Barry Tunick, President of Estes

assortment of papers, postcards, letters, etc., which documented earlier flights, were left in the box for later examination in the warmth of the Estes conference room. (We had planned to do this outdoors, but the weatherman had goofed and it was overcast, cold and windy—not at all suitable for this type of activity.)

The countdown clock was advanced to T-17 minutes. Then, with the help of Estes R&D personnel and with Mrs. Cannon at the controls, the first of two Alpha<sup>®</sup> test rockets was launched and recovered. Following readjustment of the launch rod for wind conditions, a second test Alpha<sup>®</sup> was launched, this time descending into the desired landing area.

It was now time to prep the All American Alpha for its final flight. The clock was advanced to T-7 minutes, putting us exactly on schedule for the 3:30 PM launch. Mary Roberts carefully prepped the AAA, using lots of talcum powder on its cold plastic chute. After the designated 1/2A engine was installed, the rocket was ready for launch.



Vern Estes preps the AAA

behind schedule, the countdown clock was set up beside the launch pad and started at T-30 minutes. Then, as had been scheduled in the countdown procedures, the American flag was raised and Mrs. Cannon led in the Pledge of Allegiance.

The special shipping container (tackle box) containing the All American Alpha was opened and the rocket carefully removed and examined by those present. The rocket was found to be in excellent condition, with only an occasional scrape or scratch from its previous flights. The large

As I took the rocket to the launch pad I could only hope the wind and the cold would not cause a problem. After hooking up the igniter, I backed away and Gleda, holding the E2™ launch controller in both hands, took over the final 60 second countdown.

As the clock reached T-10 seconds everyone joined in---10-9-8-7-6-5-4-3-2-1-LAUNCH! With cameras clicking and a cheer from the crowd, the All American Alpha made a perfect liftoff. But the cheers changed to O-O-O-O-Os of agony when the parachute ejected but failed to open. The cold temperature had taken its toll and we could only wait to see how much damage the rocket would sustain.

With the parachute acting as a small streamer, the rocket came down fast---landing in the weeds. The first ones to get to the landing spot just stood over it and looked. No words---nothing---they just looked. Then, after what seemed like a lifetime, someone bent over to pick it up and we could see that one of the balsa wood fins had popped off on landing. The damage was slight and with the help of a little glue, the All American Alpha would be almost as good as new.

Thirty-three of the crowd on hand signed as witnesses to the final flight of the All American Alpha. We then went inside to visit and look at the flight documentation papers stowed inside the tackle box (and add a few things of our own). Hot coffee, along with the special rocket-shaped cookies brought by Mrs. Estes, made a perfect ending to the final launching of the All American Alpha.

The AAA will now be placed on display at The Space Center in Alamogordo, New Mexico. Those of us who participated in its 51st and final flight hope we will be able to stop by the Space Center Museum someday and say hello to our old friend, the ALL AMERICAN ALPHA.



*Ignition: the All American Alpha*



*Some of the AAA memorabilia*



*An All American: have box, will travel*

## ALL AMERICAN ALPHA EPILOGUE

By Art Nestor, NAR #29623,  
Zelienople, PA

On November 5, 1992, the All American Alpha concluded its tour of the United States at its place of origin, Estes Industries. The trip included a Washington DC capitol flight (#48) raising the total number of launches to 51. It took 490 days, almost 16 months to the day. At least seven weeks were spent in layovers in various locations for repairs, bad weather, museum induction ceremonies and coordination of the final launch.

Currently, the model rocket is on display at the Space Center Museum in Alamogordo, NM (associated with the White Sands Missile Range). Bob Turner, team flyer #17, is assistant curator there and persuaded me to place the rocket in the museum on an indefinite loan basis. This means I retain ownership of the All American Alpha and can have it back anytime upon my request. About 200,000 people visit the Space Center Museum each year.

It was a lot of fun and I met a lot of people, good people, in all 50 states. And that's the real story of the All American Alpha - model rocketeers who were inspired by their hobby and their nation. Early in the project, AT&T contacted me. They noticed an increase in my out-of-state phone calls (at least two per week). They recommended I join one of their "Reach Out America" plans to save money. It did seem to help. It became commonplace for my kids to answer the phone and tell me there was a guy from some far-off state like Hawaii or New Mexico who wanted to talk to me. There were a few accents I had trouble understanding. But the surprising thing was that it didn't take any longer to reach Anchorage, Alaska than it did to call across town. I had a great time matching up faces with voices when I received photos. As of November, 1992, I had spent about \$200 in long distance phone calls, \$75 in postage and at least \$25 in envelopes and photocopying. It was worth every cent. I reached out and found fliers from all ages, professions and levels of experience in model rocketry. And even though no backup flier was used, each one received one of a limited run Certificate of Participation, similar to the one given to the person who actually made the flight. A model rocket collector's item.

Although the Alpha® is in surprisingly good shape and air-worthy, it will not be flown again. I never expected to complete the tour without some repairs being required. But if it wasn't for the "worst case scenario" mishap in California, the rocket would still be completely original. Two fins had been severely damaged and needed replacing. The entire main rocket body was repainted twice (after flights #16 and #38), with new decals added each time. However, the nose cone retains the paint job from flight #1 and naturally looks worse than the rest of the rocket. The shock cord was never replaced. We went through an unknown number of parachutes.

The tool box shipping container lasted the entire project but not without damage. After traveling many thousands of miles, our container was nearing the end of its usability. Besides numerous scuff marks and scratches, the lid has an 8 inch crack along the top front recess made for the handle. It must have taken some strong pressure or shock to do this. Now that the project is over, it has become the All American treasure chest filled with postcards, presents and memorabilia of many flights and states. It has become a collector's item in its own right.

Along the tour, each flier would put in postcards featuring something important about their area or state. Some were pretty funny. The later the flier's position in the project, the more he or she had to look at. Both times the rocket returned to me for repairs, I had to unload some of the souvenirs to lessen the weight and make more room for the Alpha®. A few notable items that later fliers missed were personalized dice from Las Vegas, native Alaskan craftwork and flecks of Alaskan gold taped on a card. No postcards or letters were removed. Some fliers generously sent gifts to me with their flight reports and although there are too many to mention here, I want to thank them publicly.

Vern Estes, legendary founder of Estes Industries, was team flier #51 for his home state of Colorado. It was Bob Cannon's idea to persuade Vern and his wife, Gleda, to participate in the project, thereby adding real historical significance. However, Bob's unfortunate illness prevented him from contacting Vern. And although I had introduced myself to Vern at a couple of rocket meets, I didn't

# All American ALPHA trivia

The All American Alpha was flown:

(see chart for names)

1. by a mechanic for Air Force One (#48)
2. in CLINTON, Iowa (#45)
3. by Vern Estes, founder of Estes Industries (#51)
4. at NARAM 33 (#5)
5. the most times (five) in the shortest month (February '92, #24-28)
6. in two states in one day (#15 & #16)
7. at White Sands Missile Range (#17)
8. at Goddard Space Flight Center (#31)
9. by only two female flyers (#29 & #49)
10. only once in one of the longest months (October '92, #50)
11. with coverage on the 6 o'clock evening news in Florida (#24)
12. with coverage in about ten different newspapers and magazines
13. just a few miles from the home of Woodrow Wilson (#29)
14. at Cape Estes, Estes Industries (#51)
15. only a few miles from the home of former President Bush in Maine (#38)
16. the same launch site as NARAM 34, but a year early (#15)
17. by a descendant of the person for whom Yale University was named (#36)

really know him. But I assembled and mailed a packet of information to him along with a request to join the team. I quickly found out what kind of a man Vern really is. He was happy to take part and, in fact, went out of his way to assist me. Vern is the kind of man who wouldn't want me rambling on any further but I'll just add that he made a special effort to provide me with photos and approaching Meerraine Cannon for me about attending the final launch. Vern is one of the founding fathers of model rocketry and we couldn't have asked for a better one.

And finally, there's the story of how the All American Alpha almost wasn't. It happened only days before the Summer 1991 "Estes Educator News" was to go to press with the first AAA application. I was on the phone with Bob Cannon discussing some small details. Bob was in Texas for an Educators' Convention. He had a bad cold and was just up from a much needed nap. We were just about to hang up and I said, "Hey, Bob, if anything goes wrong with a launch, can either Estes or I be held liable?" Right then, the entire project was put on hold. Bob hadn't considered that and wasn't in any mood to make a quick decision. We talked about lawyers, waivers, waiting a year and replacement articles. Despite my objections, the project was now in doubt. I had an anxious five days before Bob got back to me with an "all clear" from his superiors. The main responsibility would be on the fliers themselves. Whew!

If I knew at the beginning of the project what I know now, would I still have gone ahead with it? Absolutely! My only regret is that Bob Cannon was not here to share the experience. He was a real source of encouragement to me. Thanks, Bob!



The kit panel from the original Alpha® kit

# All American ALPHA Flight Log

Flight Number	State Flown In	Pilot	Hometown	Flight Date	Flight Number	State Flown In	Pilot	Hometown	Flight Date
1	Pennsylvania	Arthur Neffler	Zeneca, PA	07/04/91	27	South Carolina	Bill Edwards	Fayetteville, NC	02/22/92
2	New Jersey	Robert Kreutz	Rocky Hill, NJ	07/14/91	28	West Virginia	Chris Tuttle	Farmersville, WV	02/25/92
3	Wisconsin	John Vitek	Sheboygan, WI	07/17/91	29	Virginia	Patsy Kasek	Saunders, VA	03/11/92
4	Kansas	Tom Pouton	Topeka, KS	07/25/91	30	Delaware	Joe May	Wilmington, DE	03/21/92
5	Illinois	Laurance Bergh	Chicago, IL	08/25/91	31	Maine	Matthew Bogert	Sutton, ME	04/05/92
6	Oregon	Greg Foster	Portland, OR	09/25/91	32	New York	Geri Avadar	Hopkinton, NY	04/12/92
7	Indiana	Bill Hale	Brookville, IN	09/25/91	33	Kentucky	Colin Spooner	Hyden, KY	04/21/92
8	Wisconsin	Joe Pat	Genoa, WI	09/13/91	34	Ohio	Alex Rotschroegh	Cleveland, OH	05/03/92
9	Utah	Orion Jones	Paradise, UT	09/21/91	35	Massachusetts	Art Bumpus	Buckley, MA	05/19/92
10	Idaho	Michael Cruck	Logan, UT	09/27/91	36	Connecticut	Jeffrey Yale	Willingford, CT	05/28/92
11	Wyoming	Orion Jones	Paradise, UT	10/05/91	37	New Hampshire	Jonathan Chikara	Hudson, NH	06/04/92
12	Washington	Bill Gray	Richland, WA	10/15/91	38	Maine	Rose Burrows	Kennebunk, ME	06/10/92
13	Arizona	Scott Batterside	Archorage, AK	10/24/91	39	Michigan	Dean Prater	Warren, MI	06/25/92
14	California	Don Sheppard	Healy, CA	11/04/91	40	South Dakota	Nathan Edwards	Aberdeen, SD	07/04/92
15	Nevada	Tom Dossan	Henderson, NV	11/16/91	41	North Dakota	Nathan Edwards	Aberdeen, SD	07/10/92
16	Arizona	Bob Sanford	Las Vegas, NV	11/16/91	42	Minnesota	Juergen Berg	Glenwood, MN	07/20/92
17	New Mexico	Robert Turner	Albuquerque, NM	12/06/91	43	Oklahoma	Ron Oyst	Broken Arrow, OK	08/01/92
18	Missouri	Kent Sauer	Ranbyville, MO	12/21/91	44	Arkansas	Karl Sivicki	Polkville, MO	08/16/92
19	Alabama	Matthew Spieris	Mobile Shoals, AL	12/19/91	45	Iowa	William Morkuty	Clinton, IA	08/25/92
20	Tennessee	Matthew Spieris	Mobile Shoals, AL	01/01/92	46	Florida Island	Paul Vercell	Curtisland, RI	09/02/92
21	Mississippi	Michael Harris	Greenville, MS	01/20/92	47	Vermont	Irene Corbin	South Hero, VT	09/05/92
22	Louisiana	James Harris	Greenville, MS	01/22/92	48	District of Columbia	Jay Berger	Sutton, MD	09/13/92
23	Texas	James Harris	Frankford, TX	01/27/92	49	Montana	Evans Young	Poplar, MT	09/19/92
24	Florida	Jason Rook	Jacksonville, FL	02/01/92	50	Hawaii	Michael Masuda	Honolulu, HI	10/28/92
25	Georgia	Deah Houdeshell	Austin, GA	02/05/92	51	Colorado	Yvonne Erbs	Canon City, CO	11/04/92
26	North Carolina	Bob Spohn	Erhi College, NC	02/18/92					

## ENTER THE ESTES DESIGN CONTEST AND WIN BIG PRIZES!

Here are the rules for the contest:

- All entries become the property of Estes Industries and cannot be returned.
- Employees of Estes Industries and members of their immediate families are not eligible.
- Any type of model rocketry design can be entered (rockets, boost-gliders, launch or recovery devices, etc.)
- Designs should be new, original, and different. They also need to be workable. The goal is to develop something new that other rocketeers can build and use successfully, too.
- Entries will be judged on practicality, originality, neatness, completeness, and clarity. **All plans must be flight-tested and proven safe and successful.**
- Winning entries may be published in *Model Rocket News* and/or other Estes publications.
- Your design entry should include a parts list and any instructions or diagrams you feel will be helpful. Include a list of the engines with which the entry has been successfully flown (if a flying rocket). Be sure that your name and address are on each page of your entry.
- Please do not send the actual model unless requested as it cannot be returned.
- Photos of the entry are greatly appreciated, but are not required. However, photo-documentation of your entry may help it win.
- You may enter as many times as you like.
- New contest every quarter (January-March, April-June, July-September, October-December).

- All designs reaching Estes Industries during that quarter will be entered in that quarter's competition. Date of receipt, not postmark, will determine the quarter in which the design is entered.
- If two or more exceptional entries are received during any quarter, the judges may, at their discretion, make identical awards.
- Designs should be sent to:  
**Estes Industries  
1295 H Street  
Penrose, CO 81240**
- All plans sent to us not specifically addressed to another contest or department will automatically be placed in the Estes Design Contest.
- Each quarter's winner will receive a \$100 merchandise certificate and an award suitable for framing. Award winners will be notified by mail.

A few tips to help you with a winning entry:

- Make sure your designs are built and test flown.
- Include a parts list.
- Make sure the drawing of the rocket (or device) is complete and includes a pattern for the parts (such as fins, etc).
- Be neat!

We are looking for uniqueness, innovation and proven performance!

# GOOD LUCK!

## DESIGN OF THE QUARTER

In the last two quarters of 1993 we had some real exciting designs. The judges tell me they had an especially tough time with the fourth quarter.

### Third Quarter 1992

The winner of this quarter is **Scott Tyrell** of Bensalem, PA with a futuristic-looking craft, the "Orbital Payload Booster". Two honorable mentions for this quarter go to **James Primrose** of Cedar Rapids, IA with his "X-2" and **Steve Schrader** from Las Vegas, NV with his two rear ejecting parachute design called the "Twin Chuter". On James' "X-2", I would like to point out that the judges were impressed with the experimental and analytical process he used in designing a swing wing glider.

### Fourth Quarter 1992

In the fourth quarter, the judges were torn between Asheville, NC's **William McLoughlin** and his rather large "D"-powered rocket glider, the "White Lightning" and **Stan Batchelor** of Mill Valley, CA and his incredible two-stage, double-clustered "Double Trouble". The judges decided to award a tie.

In this quarter, we had three honorable mentions. The first going to **Paul Malone** of Warwick, RI and his unique, odd rocket called the "Gnat" (which used the rubber tip from a shuttlecock - or birdie - as a nose cone). **Dean Pilato's** "Skimmer" (and everyone knows that Dean is from Warren, MI), once again with a unique futuristic design, made it to the final round. The judges would also like to pass on a special honorable mention to **Daniel Schubotz** of Baton Rouge, LA for his nifty little semi-scale design of a TR-1A (a U-2 derivative).

The Design of the Quarter judges and the rest of the folks here at Estes would like to pass on our congratulations to the winners.

# ROCKET MODELER QUESTIONNAIRE

Please answer these questions as completely as you can. Your answers will help us provide you with better products and services. Remember these are your observations - there are no right or wrong responses.

To prevent damage to your MRN, you may wish to photocopy this page or write the answers on another sheet of paper.

Send your complete questionnaire to: Estes Industries MRN Survey 1295 H Street Penrose, CO 81240

1. How long have you participated in model rocketry?  
 0-3 months       1-5 years  
 3-12 months       More than 5 years
2. How did you find out about Estes rocketry for the first time?  
 Magazine       School/club  
 Hobby shop       Toy store  
 Friend       Other \_\_\_\_\_
3. Why did you decide to give Estes rocketry a try? (Please explain fully.)
4. How would you rate your first experience with Estes rockets?  
 Excellent       Poor  
 Good       Other  
 Fair  
Please explain your response.
5. What do you like more?  
 Flying rockets       I like both equally well  
 Building rockets       Other (explain)
6. Why is Estes model rocketry exciting for you?
7. What would you say keeps you interested in building or flying more Estes rockets?
8. Are you  
 More       About the same  
 Less  
interested in rockets now than when you first started?
9. What do you like or dislike about Estes, its publications or its products?
10. Do you fly Estes rockets  
 On your own       With friends  
 With a parent       As a class or club activity  
Check as many as appropriate, circle the one you do most.
11. If your first building and flying of an Estes rocket was in school, do you see this as the start of a hobby activity outside of school for you?  
 Yes Why?  
  
 No Why not?
12. Where do you usually purchase your Estes supplies?
13. Are you receiving  
 Excellent       Adequate  
 Good       Poor  
support/service from your Estes model rocket supplier?
14. If you have built or flown Estes rockets in the past, but do not now, why did you stop?

Thanks for your support and help.



ESTES INDUSTRIES  
1295 H STREET  
PENROSE, CO 81240 USA

BULK RATE  
U.S. POSTAGE PAID  
ESTES INDUSTRIES