

## **DESIGNERS KIT**

**ALL THE PARTS YOU NEED TO BUILD TWO  
MODEL ROCKETS**

**FOR USE WITH A, B, C OR D-ENGINES**

2 in 1 PARTS LIST

Body Tube T-2



Nose Cone N2



Body Tube T-3

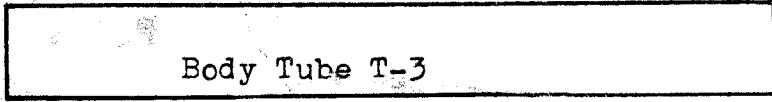

N-3  
Cone

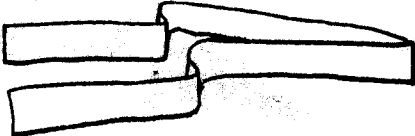
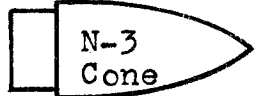

Two Streamers



Two Shock Cords



2- Screw Eyes

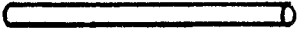

Two Launch Lugs



2- Large Centering Rings



2- Small Centering Rings



2- Engine Blocks

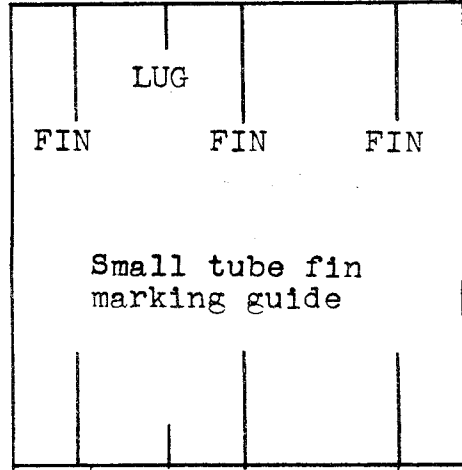
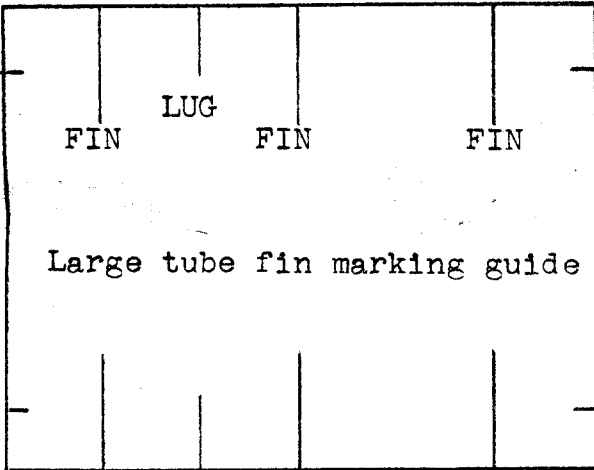

FIN ALIGNMENT GUIDE

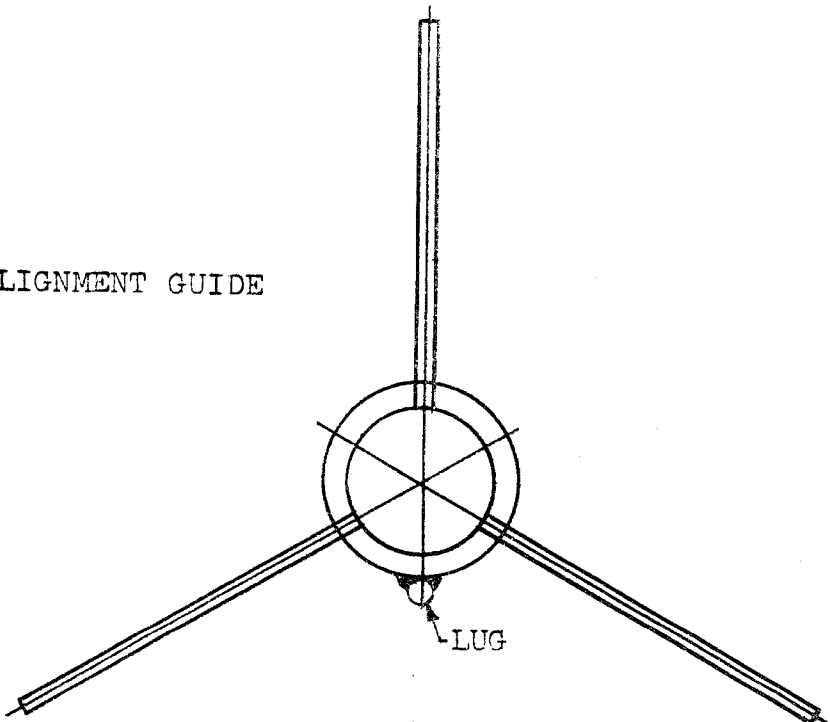

ASSEMBLY INSTRUCTIONS

- 1 - CUT OUT SMALL BODY TUBE MARKING GUIDE, TAPE AROUND TUBE AND MARK OFF SPACES FOR FIN PATTERN "A".
- 2 - USING TEMPLATES, MARK & CUT OUT FINS "A" & "B"(4-EACH) AND TAPER LEADING EDGES.
- 3 - GLUE FINS "A" FLUSH WITH END OF BODY TUBE.
- 4 - SLIP FIN RING OVER FINS "A", ADD GLUE FILLET TO BOTH SIDES OF FINS.
- 5 - CUT OUT LARGE TUBE MARKING GUIDE, TAPE AROUND TUBE AND MARK OFF SPACES FOR FINS "B". THESE MARKS SHOULD LINE UP WITH FINS "A". SEE PLAN VIEW FOR ALIGNMENT.
- 6 - GLUE FINS "B" TO FIN RING. CHECK ALIGNMENT WITH FINS "A".
- 7 - GLUE LAUNCH LUG FLUSH WITH END OF BODY TUBE.
- 8 - CUT TWO SLOTS 1/4" APART 1-INCH FROM FRONT OF BODY TUBE, INSERT SHOCK CORD THRU SLOTS AND ADD GLUE.
- 9 - GLUE SCREW EYE TO NOSE CONE.
- 10 - TIE SHOCK CORD AND STREAMER TO SCREW EYE.
- 11 - APPLY RING OF GLUE WITH A STICK 2 1/2" INTO REAR OF BODY TUBE. INSERT ENGINE BLOCK & WIPE OFF EXCESS GLUE.

PARTS LIST

- |                   |   |
|-------------------|---|
| 1 - NOSE CONE     | 1 - STREAMER MATERIAL                   |
| 1 - BODY TUBE     | 1 - LAUNCH LUG                          |
| 1 - FIN RING TUBE | 1 - FIN SHEET                           |
| 1 - SCREW EYE     | 1 - ENGINE BLOCK                        |
| 1 - SHOCK CORD    | WADDING REQUIRED - NOT FURNISHED IN KIT |

