

ASSEMBLY INSTRUCTIONS with Detail Sketches



F.S.I. 1/8 SCALE MODEL

CANADIAN SOUNDING ROCKET

BLACK BRANT II

This sophisticated bird is unequalled for beauty and performance. Kit features include a 22" Nylon parachute, precut fins, precut balsa boattail, as well as scale decals.

SPECIFICATIONS:

Length----- 41.5 inches
Body Dia.-- 2.1 inches
Approx. Weight
without engine- 9.5 ozs.

Recommended F.S.I. Engines
E60-4, E60-6, F100-6, F100-8, F100-10

CAT. NO. MRK-14

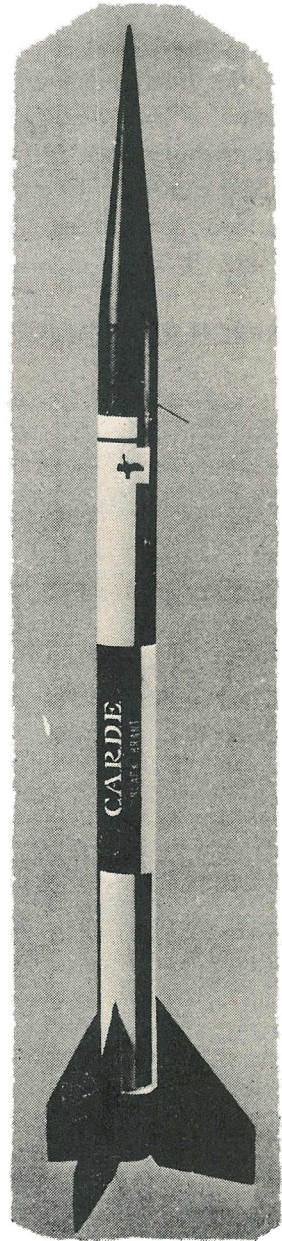
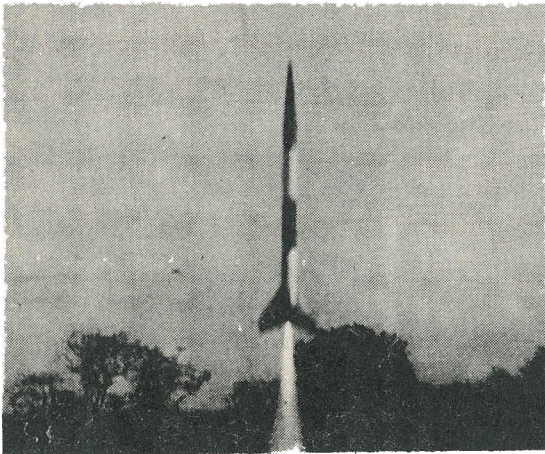

CC II A IG Decal
on fins

FLIGHT SYSTEMS, INC.

9300 EAST 68th STREET
RAYTOWN, MISSOURI 64133

FOREWORD

It has been the intentions of Flight Systems, Inc., in producing this fine bird, to bring the rocketeer an exceptional flying model. This we have done, as you will see when you launch your Black Brant for the first time. We have included some information on scale detailing, as well as a brief synopsis of the history and make up of the Black Brant. This information, while accurate, is by no means complete. In our travels to rocketry contests we have repeatedly seen a rocketeer with a perfectly fine scale model lose the contest simply because he used only the information given him by the manufacture when building his model and when writing the required article about the model. In other words, very little research was done by the modeler in establishing himself as an authority on the particular model he had chosen, even though he may have spent long hours in building the model. We feel that the Black Brant II is a winner if someone out there will do the research necessary to be a winner. Therefore we are including the following, for those rocketeers interested in obtaining additional information about the Black Brant.

National Aeronautics and Space Administration
Washington, D.C. 20546

Ask for NASA Photo No. 1-61-8226

These people can be of great assistance to you in your search for more information.

BLACK BRANT II

ASSEMBLY INSTRUCTIONS:

1. Lay out and check parts to be sure all are present. Read and familiarize yourself with all instructions and details before beginning construction.
2. Find the following parts: 3 - plywood centering rings (2" outside diameter), 1 - plywood centering ring (1.4" outside diameter), 1 - engine holder/snuffer tube (1.13 x 18"), 1 - balsa boat tail. Glue the 1.4" centering ring into the small end of the balsa boat tail. Glue one of the 2" centering rings to the larger end of the boat tail. Let this assembly dry before proceeding. Use a good quality white glue for all assembly work. Assemble all of the above parts and glue in place as shown in Detail A. Apply fairly thick glue fillets to all parts as noted in detail. Set this assembly aside to dry thoroughly.
3. Study Detail B and the following procedure before attempting this next step. First slide the engine holder/snuffer tube assembly (from instruction 2) into the 2" x 18" body tube to check for fit. Remove it. If necessary sand any parts which fit too tightly. Now insert just the end of the engine tube into the body tube as shown in Detail B-Step 1. After inserting engine holder/snuffer tube to this point, apply a ring of glue inside the 2" body tube. (Also shown in Step 1) Continue to push the assembly into the body tube until the second centering ring has entered about an inch or so. At this point, quickly apply another ring of glue just inside the body tube as noted in Detail B-Step 2. Continue pushing the engine holder/snuffer tube assembly into the body tube until the balsa boat tail has entered the body tube and is positioned as shown in Detail B-Step 3. Study the above procedure and practice it several times without the glue so you can make one smooth operation out of it. Otherwise you may find yourself struggling to either push the assembly into position or to remove it. As mentioned earlier, if parts seem to fit too tightly you may wish to sand the edges of the centering rings before attempting to install the assembly permanently. Align the boat tail with body tube if it is not already fairly straight with tube.

4. Apply a glue fillet to the front centering ring as per Detail B-Step 4. Set this entire assembly in a position so that the boat tail end is down and allow the glue to dry.
5. Install split tube coupler in top of the above completed assembly. See Detail C. Glue in place and allow to dry. Be sure it is aligned straight with body tube as shown in Detail C. At this time it is a good idea to sand the boat tail until its surface is flush with the body tube.
6. Slide the 2" x 5" section of body tube over the coupler(just installed)until it is against the the 2" x 18" section. Glue in place. Find a flat surface such as a table top and lay the assembled body tubes on it. Now roll the assembly on this flat surface to insure that the body tubes will be in perfect alignment. This must be done immediately after gluing in order be sure that tubes line up. Allow this assembly to dry. The split ring coupler causes less shrinkage at the joint. Thus a better finish can be obtained more easily.
7. After the above is completed and before installing the fins you may wish to sand and partially finish the grooved area near the boat tail end of the rocket body as this area can be rather difficult to work on after the fins are attached.
8. Glue the 2"diameter balsa block half way in one end of the 2" x 3" section of body tube. Be sure it is aligned straight with body tube. See Detail D. For all practical purposes (unless you are going to fly a payload of some sort) you may at this time glue the nose cone in place at the other end of this body tube section as shown in Detail D. If you do not wish to glue the nose cone in place be sure that it fits fairly tight. If it is too loose wrap the end with masking tape until a tight fit is obtained.
9. Insert eye screw in center of balsa block as shown in Detail D. Remove eye screw and saturate area in and around hole which is left with white glue. Re-install eye in this hole and allow to dry. Spreading white glue on balsa around eye screw will strengthen it at this point and prevent eye from pulling out.
10. Sand and shape fins. DO NOT sand root edge (red edge) of fins. Much time can be devoted to shaping fins for a true scale model as shown in the scale fin detail. This model has been thoroughly tested with both scale fin shapes and with fins which have simply had the leading edges rounded and the trailing edges tapered. The Brant flies extremely well with either.
11. Once the fins have been shaped as desired, they are ready to be installed on the rocket body as shown in Detail E. First mark the location of the fins on the body tube as shown in the detail. Use the "Fin Placement Guide" enclosed with this kit. Draw lines along the body tube to align fins on. With a sharp instrument such as a compass point or a knife, punch 3 small holes (as illustrated) in the body tube at the approximate locations shown along each of the three fin alignment lines you have just drawn. These holes allow the glue to run into the body tube when installing the fins for a much stronger bond of fins to the rocket body.
12. It is a temptation to try to install all of the fins at one time. However, it soon becomes apparent that a much easier method is to install one fin at a time and let it dry before attempting to install the next one. Spread a small layer of glue on the root edge (red edge) of the fin to be installed. Let this glue soak into the wood and dry somewhat. Spread on more glue and attach the fin to the body tube on one of the alignment marks. Be sure you get the fin perfectly aligned with the body tube. Allow fin to dry. Repeat this procedure with each of the remaining fins, allowing each fin to dry thoroughly before attempting to install the next one. Enough cannot be said about fin alignment. Fins must be straight with the body tube for best flights.
13. After fins are in place , proceed to add layers of glue fillets as shown in Detail F. On this particular rocket we at F.S.I. often use a layer of 5 minute epoxy as the final layer for added strength. Stabilizer fins on the Black Brant must be strongly attached because of their size and the velocity of the F100 engine at lift off.

14. Attach 4 foot shock cord to body tube and eye screw as shown in cutaway drawing and in Detail G.
15. Attach launch lugs in positions shown on cutaway drawing. Align them straight with body tube and each other. We strongly recommend using a 1/4 inch launch rod when flying the Brant. Therefore you will find only 1/4 inch launch lugs enclosed with this kit. (You may wish to finish your model before adding launch lugs. In this way you do not have to be constantly sanding around them. If you choose this procedure, be sure to scrape the finish at the points where you are installing the lugs after finishing.)
16. Insert the engine thrust ring as shown in Detail H. It may be installed in the position shown, in the engine holder/snuffer tube, by measuring or by using an actual engine to push it into position. When engine is fully against the thrust ring it should protrude from rear of rocket 1/2". Before inserting thrust ring apply a ring of glue inside the tube. Thrust ring will force this glue ahead of itself as it is being pushed into position. DO NOT allow any glue to remain in actual engine compartment as it will then be difficult to install actual engine.
17. Your bird is now complete and ready for finishing; and if you wish, scale detailing. The birds pictured were first sanded. Then up to 7 and even 10 or more very thin coats of orange (not white) shellac were applied. Each coat was lightly sanded before the next was applied. Thus there was not a large build up of shellac except in the deeper depressions. Next, flat black quick drying enamel was sprayed on. After black was thoroughly dry, our birds were masked off in an appropriate manner. Flat white quick dry enamel was then sprayed on. The approaches to finishing are many and varied. The above is only one and has worked well for us. Many modelers prefer to use model airplane dope. Remember, any really fine finish is very time consuming.
18. After the paint on your finished rocket has dried, add decals. Antennas may be installed by punching or drilling very small holes in the nose cone section. Install antennas by putting a very small amount of 5 minute epoxy on the end of each antenna as shown in detail I. Insert each antenna in the holes you have made in the tube. Position them as shown and allow to dry. (For decal locations see Instruction Cover.)
19. For fine detailing, locate simulated phillips head bolts in the approximate positions shown in Detail J. There are many methods of doing this. None are easy and all are quite time consuming. The method used on the models pictured in this kit was to take a small sharp drill bit of the approximate size we wanted the "bolts" to appear and lay the point of this bit at the position where we wished to "make a bolt". By turning the bit between our fingers we were able to actually drill away the painted surface at this point. A tiny artist brush was then used to touch up the shallow hole with aluminum paint, thus giving the appearance of a tiny bolt. Please note before forming bolts at the nose cone tip, that a groove should be lightly scored in the painted surface as shown in Detail J. Use masking tape for a guide and a very sharp modeling knife. Work slowly and carefully. (While detailing is impressive, you may wish to skip this part if you are strictly a "sport flyer", and not entering a scale contest. The Black Brant is quite impressive, even plainly finished, and it has no equal for performance.)
20. After your bird is finished to your satisfaction, attach the nylon parachute as in Detail K. Also attach the small plastic drag chute to the nose cone as shown. This helps to slow the nose cone as it is ejected from the body of the rocket during the recovery phase of the flight.
21. Your model is now ready for launch preparations. Choose an appropriate F100 engine. Generally speaking an F100-6 should allow your parachute system to eject

near the apogee of the flight path. An F100-8 will allow the bird to descend a few feet before parachute ejection. Use of a short time delay such as an F100-4 should be done only if you are carrying a heavy payload. Wrap your engine with masking tape as shown in Detail L, so that about 10 pounds of force is required to push the engine into the engine compartment in your rocket. (This will prevent the engine from ejecting rearward when the recovery phase of the engine burn occurs.) Push engine into rear of rocket until it touches thrust ring. Nozzle end of rocket engine should protrude about 1/2 inch if thrust ring is properly placed. Insert a 1 & 1/2 inch ball of flame resistant wadding into snuffer tube from the nose cone end of the rocket. Tamp this in place with a dowel rod or similiar instrument. Next insert enough flame resistant wadding into nose cone end of rocket to completely cover snuffer tube opening and to fill the bottom of the parachute chamber with about an inch and a half of wadding. Lightly pack this in place. Spike nylon parachute and fold in half. Insert it into parachute chamber as shown in cutaway drawing. Insert shock cord and small plastic drag chute. At this time push nose cone section onto rocket. Nose cone section should fit snug but not extremely tight. If it is too loose, wrap a small piece of masking tape around it until a snug fit is obtained to prevent premature parachute ejection. Your bird is now ready to launch.

22. When you reach the launch site and have everything ready, position the Black Brant on the launch stand. For this rocket we recommend you use only a launch system with a 1/4th inch diameter launch rod. Once your bird is in position on the launch stand install ignitor in engine as per the instructions with the engine. Hook up the launch circuit, again, as per the instructions with your engine. Clear the immediate area of spectators. Be sure that everyone in and around the area knows of the impending launch. Make a last minute check for aircraft in the vicinity. Begin the count down, 5, 4, 3, 2, 1, Ignition, Liftoff!!!!

FLIGHT SYSTEMS, INC. HAS DESIGNED THIS ROCKET FOR THE F.S.I. E60 AND F100 ROCKET ENGINES. WE RECOMMEND THAT YOU USE ONLY THESE MOTORS.

CAUTION: DO NOT launch this or any other model rocket on extremely windy days.

((((((((((((((((((((((((((((PARTS LIST))))))))))))))))))))))))))))

Qty	Description	Qty	Description
1	2.1 x 18" Body Tube	1	Plastic Parachute Canopy
1	2.1 x 5" Body Tube	8	Shroud Lines
1	2.1 x 3" Body tube	8	Parachute Tabs
1	Split Ring Tube Coupler	2	Snap Swivels
1	2" dia. Balsa Bulkhead	1	Eye Screw
1	Nose Cone	2	1/4" Launch Lugs
1	Balsa Boat Tail	1	Shock Cord
3	Precut Fins	1	Shock Cord Anchor
1	Engine Holder/Stuffer Tube (1.130 x 18")	1	Flame Retardant Wadding
1	Centering Ring (Outside Dia. 1.4")	3	Antennas
3	Centering Rings (Outside Dia. 2")	1	Set of Decals
1	22" Nylon Parachute with Shroud Lines	1	Fin Placement Guide
1	Thrust Ring	1	Set of Instructions

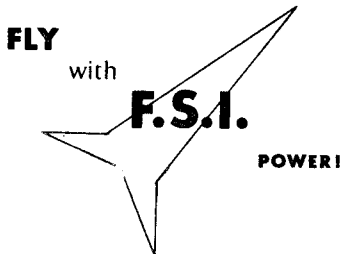

Thrusters!



FLIGHT SYSTEMS, INC.
9300 East 68th Street
Raytown, Missouri 64133

CUTAWAY DRAWING OF
BLACK BRANT II

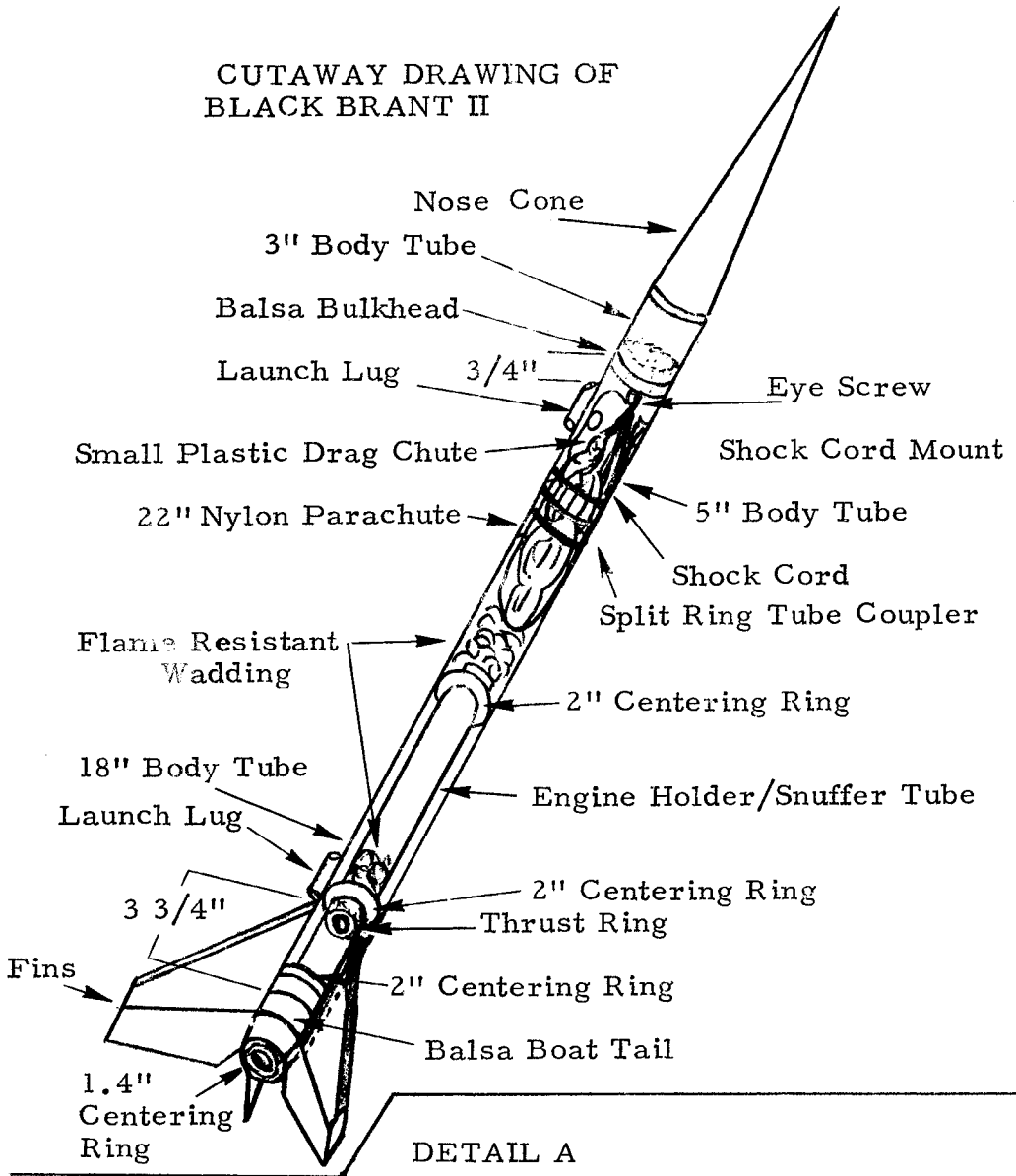

2 inch O.D. Centering Ring. Locate 13 1/4 inches from indicated end of tube.

2 inch O.D. Centering Ring glued to front of boat tail

1.4 inch O.D. Centering Ring. Center and glue in place as indicated in instruction 1.

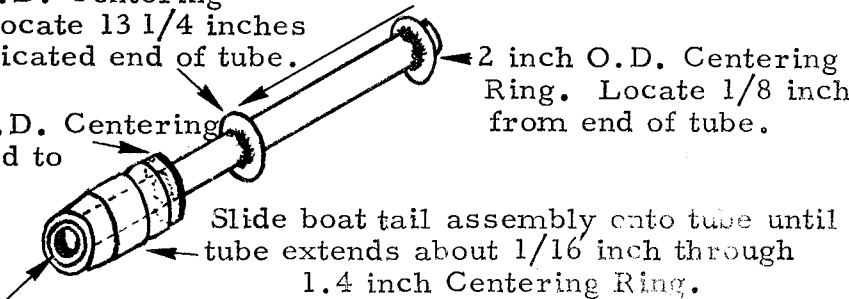

DETAIL B

Step 1

Engine Holder/Snuffer Tube
Assembly

18" Body Tube

Apply ring of glue
inside here.

Step 2

Push this assembly to
this approximate
position in body
tube.

Glue applied in Step 1
is being pushed ahead of
this centering ring.

Apply another ring of glue here
as described in Instruction 3.

Step 3

Boat Tail Assembly in
final position

Step 4

Apply white glue all around
front centering ring here.

5" Body Tube

DETAIL C

Sand Boat Tail flush
with body tube.

Glue split ring coupler
coupler half way into
body tube here. Be sure
it is in proper alignment so
5" body tube will line up with the
rest of the body when it is installed.

DETAIL D

2 inch Balsa Block

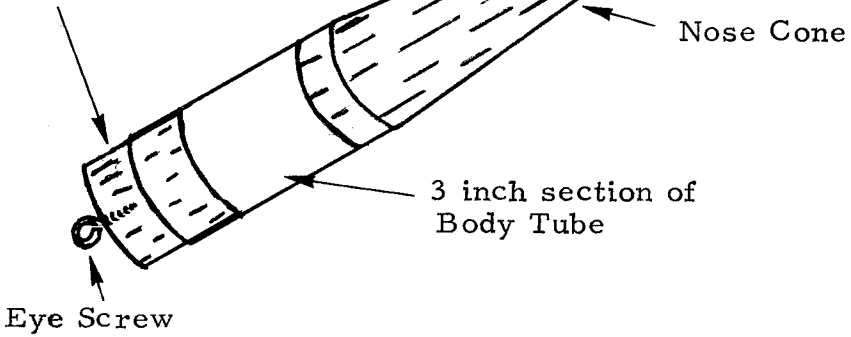

DETAIL E

Red edge of fin is root of fin and goes next to body tube.

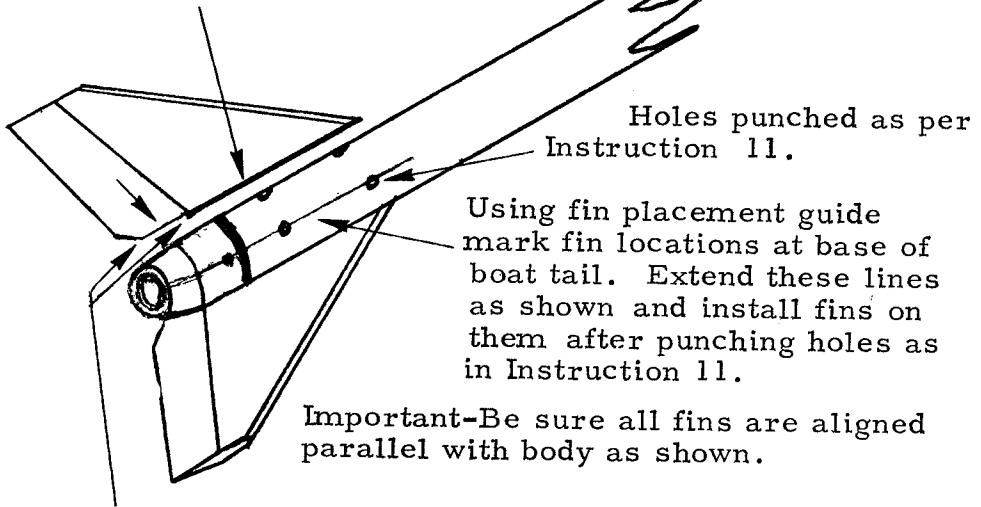

For true scale effect you will want to sand this part of fin as shown so that it is about $1/16$ " from and not attached to the boat tail when the fin is glued into position. If you are a sport flyer and not particularly interested in meticulous details go ahead and glue fin along the entire root edge for added strength.

Simulated fin attachment ring
in boat tail area

DETAIL F

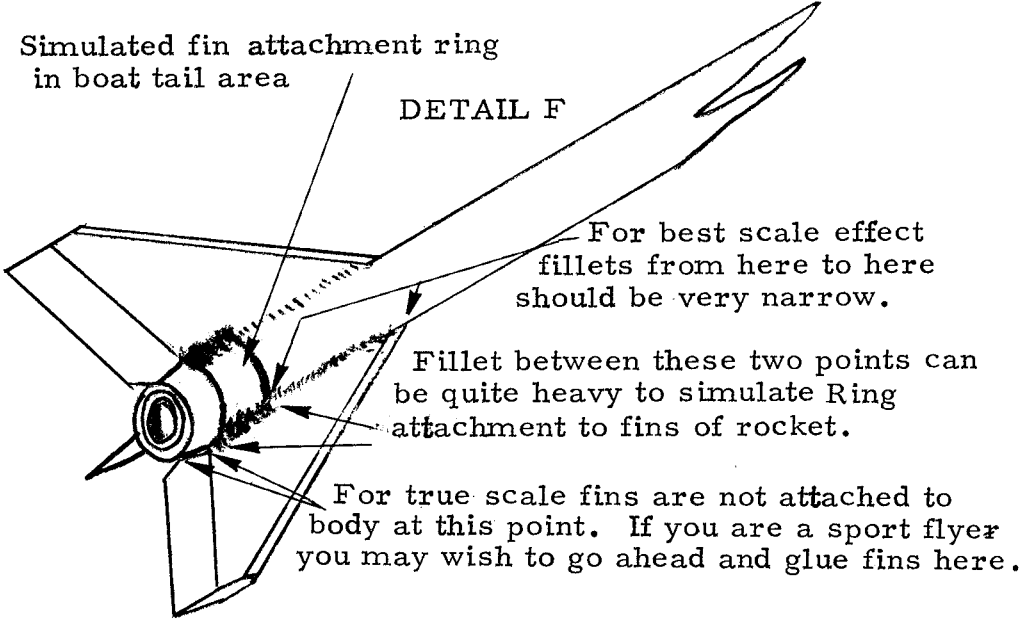

DETAIL G

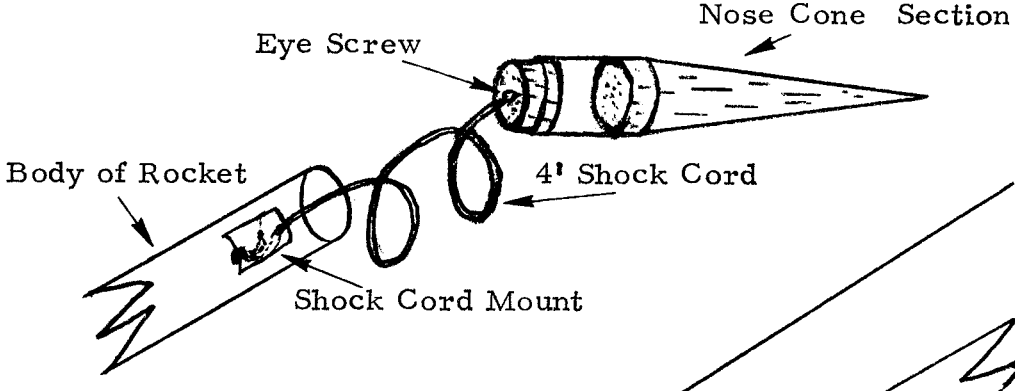

DETAIL H

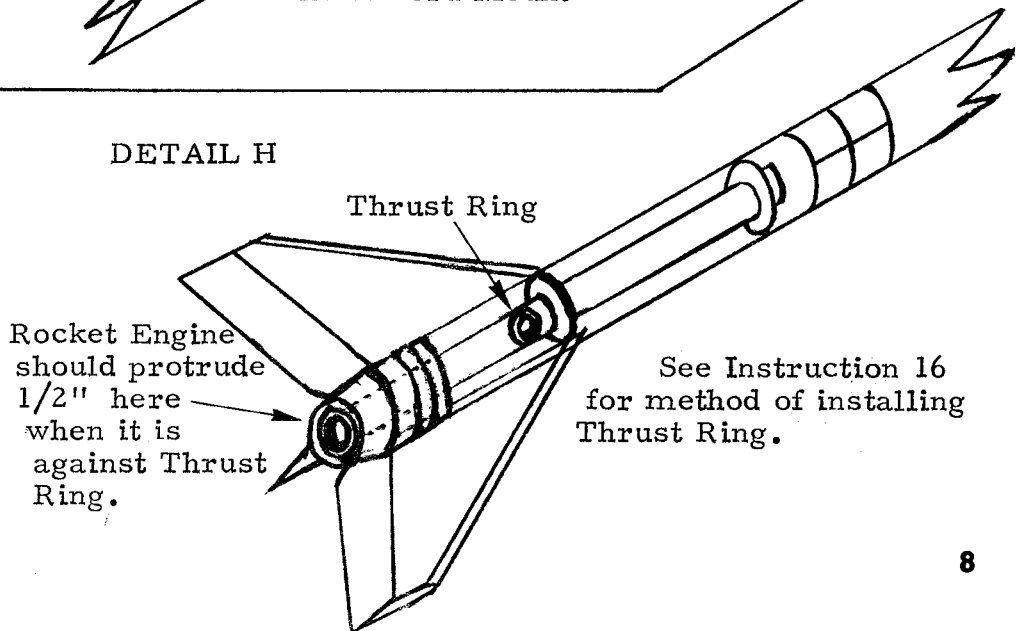

DETAIL I

When inserting antenna let a small amount of epoxy set around antenna at point shown.

4 small simulated flat phillips head bolts around each antenna

3/8" from edge of 3" Body Tube as shown

Antenna (actual size)

Space Antennas an equal distance apart around body as when installing 3 fins.

Bend antennas to this approximate angle

1 1/4"

DETAIL J

10 Flat Head Phillips Bolts equally spaced and flush.

1/16"

16 Flat Head Phillips Bolts equally spaced and flush.

14 Flat Head Phillips Bolts equally spaced and flush.

4 rows of random spaced bolts or weld spots. Refer to NASA Photo No. L-61-8226

Two Rows of 3 Flat Head Phillips Bolts equally spaced and flush between adjacent fins

6 Flat Head Phillips Bolts flush and equally spaced between adjacent fins.

DETAIL K

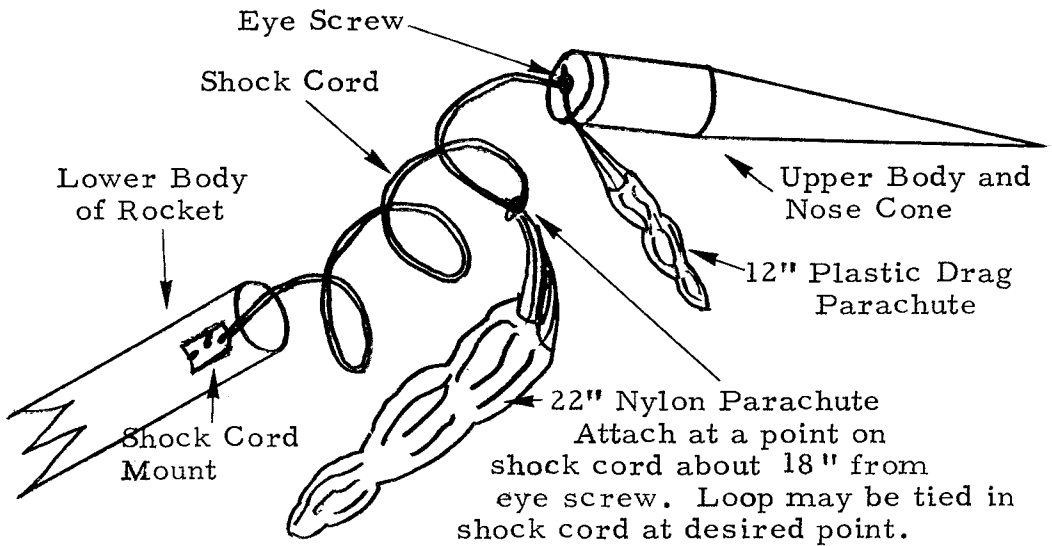

Cut plastic canopy for 12" drag parachute. Assemble and fold as shown.

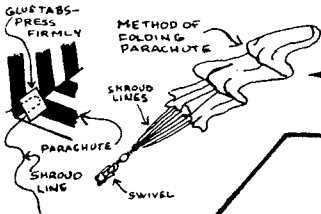

DETAIL L

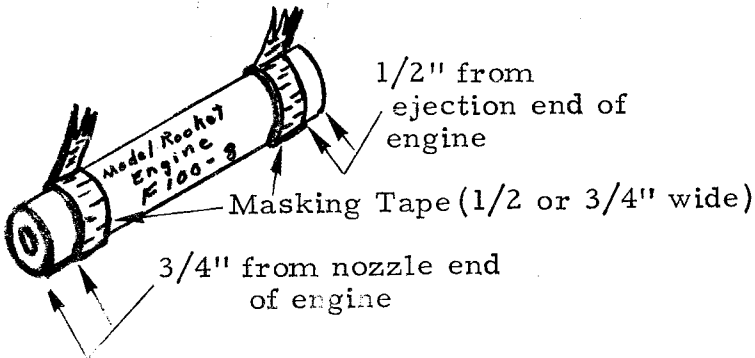

FLIGHT SYSTEMS, INC.

9300 EAST 68th STREET
 RAYTOW J. MISSOURI 64133

BLACK BRANT II

History and General Information

In 1956 the Defence Research Establishment Valcartier (then known as the Canadian Armament Research and Development Establishment, or CARDE) began to formulate and produce high performance solid propellant rocket motors. CARDE developed the Black Brant I, the first exclusively Canadian sounding rocket, as a test vehicle for their thrusters (rocket motors). During the late 1950's, thirteen Black Brant I's were launched, thus proving the reliability of the CARDE thrusters.

The Black Brant II, a high altitude research vehicle, was a resultant of the Black Brant I program. Black Brant II rockets were capable of carrying 150 pound payloads to altitudes of 100 statute miles. Later versions of the Black Brant II had a four fin design and an updated motor with 20,000 pounds of thrust and a thrust duration of 23 seconds. These vehicles could carry a 150 pound payload to an altitude of 150 miles.

Early versions of the Black Brant were built from a magnesium-zirconium alloy. The main structure of the fins were constructed of this same material with phenolic asbestos leading and trailing edges. The later four fin models incorporated a lightweight aluminum alloy fin covering.

The finish on the Black Brant II had a dull or flat appearance. To aid in analysis of vehicle altitude and attitude during flight, roll patterns were added to the motor casing in flat white. Several distinct patterns seem to have been used. The one on the model pictured with this kit is perhaps the most complicated. It was taken from a round launched by NASA at their Wallops Island test site. The motor casing was divided into three equal parts along its length. The first third was divided into two circumferential patches, one white, one black. The mid third was divided into four circumferential patches, alternating black and white. The last third near the fins was divided into eight circumferential patches, alternating black and white. Roll patterns varied. On some Brants the motor casing was divided in half length ways and each half was divided into two circumferential patches, alternating black with white. Some vehicles had black and white patterns on the fins while others had all black fins. Placement of the lettering and the silhouetted Canada goose also varied. On some of the Black Brants the initials C.A.R.D.E. were painted black on a white background.

Canadian firings of the Black Brant series of sounding rockets are predominately in the Canadian Northlands.

Black Brant II Specifications:

Dimensions-

Outside Diameter	17.2 inches
Overall Length	332.0 inches
Nosecone Length	86.0 inches
Payload Section	24.56 inches

*Engine Specifications-

Propellant Weight	2,000 lbs.
Thrust Duration	26 sec.
Average Thrust	16,000 lbs.
Total Impulse	420,000 lb/sec.

Total Vehicle Weight-2,782 lbs.

*Approximations

SCALE FIN SHAPING DETAIL

Leading edge taper begins 1/4" back on fin as indicated.

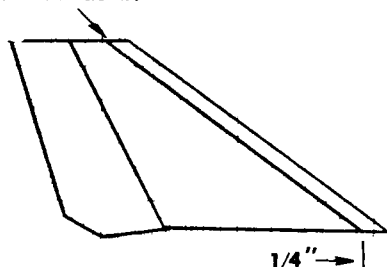

Root edge of fin 1/4" thick at this point and tapered both ways toward leading and trailing edges as with tip.

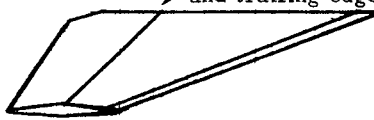

Tip of fin 1/8" thick at this point and tapered as shown.

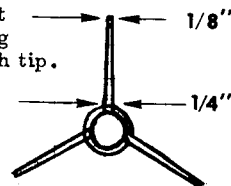



FIN PLACEMENT GUIDE

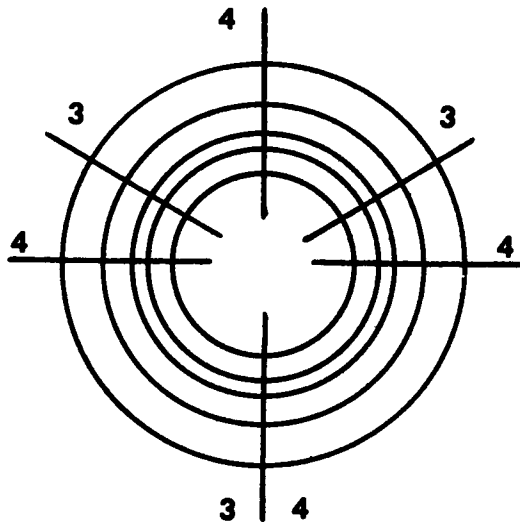

1. Center end of tube in the proper circle.
2. Mark (4) lines for four fin models and (3) lines for three fin models.

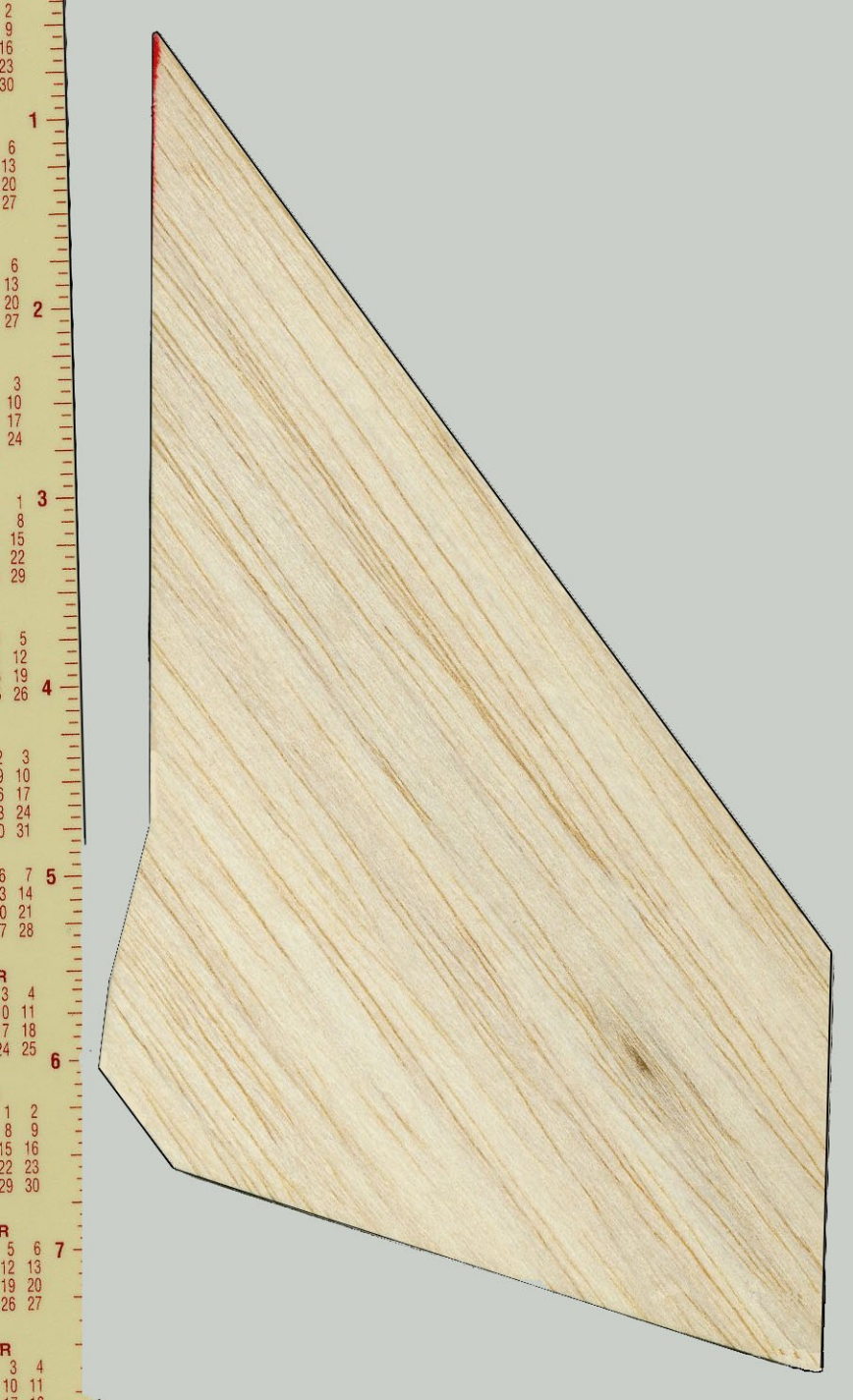

9
16
23
30
1
6
13
20
27
6
13
20
27
2
3
10
17
24
3
1
8
15
22
29
5
12
19
26
4
3
10
17
24
31
5
6
13
20
27
28
R
3
4
10
11
17
18
24
25
6
1
2
8
9
15
16
22
23
29
30
R
5
6
7
12
13
19
20
26
27
R
3
4
10
11
17
18



TODAY
1993

S M T W T F S
JANUARY

1 2 3 4 5 6 7 8 9 10 11 12 13 14 15 16 17 18 19 20 21 22 23 24 25 26 27 28 29 30 31

FEBRUARY

1 2 3 4 5 6 7 8 9 10 11 12 13 14 15 16 17 18 19 20 21 22 23 24 25 26 27 28 29

MARCH

1 2 3 4 5 6 7 8 9 10 11 12 13 14 15 16 17 18 19 20 21 22 23 24 25 26 27 28 29 30 31

APRIL

1 2 3 4 5 6 7 8 9 10 11 12 13 14 15 16 17 18 19 20 21 22 23 24 25 26 27 28 29 30

MAY

1 2 3 4 5 6 7 8 9 10 11 12 13 14 15 16 17 18 19 20 21 22 23 24 25 26 27 28 29 30 31

JUNE

1 2 3 4 5 6 7 8 9 10 11 12 13 14 15 16 17 18 19 20 21 22 23 24 25 26 27 28 29 30

JULY

1 2 3 4 5 6 7 8 9 10 11 12 13 14 15 16 17 18 19 20 21 22 23 24 25 26 27 28 29 30 31

AUGUST

1 2 3 4 5 6 7 8 9 10 11 12 13 14 15 16 17 18 19 20 21 22 23 24 25 26 27 28 29 30 31

SEPTEMBER

1 2 3 4 5 6 7 8 9 10 11 12 13 14 15 16 17 18 19 20 21 22 23 24 25 26 27 28 29 30

OCTOBER

1 2 3 4 5 6 7 8 9 10 11 12 13 14 15 16 17 18 19 20 21 22 23 24 25 26 27 28 29 30 31

NOVEMBER

1 2 3 4 5 6 7 8 9 10 11 12 13 14 15 16 17 18 19 20 21 22 23 24 25 26 27 28 29 30

DECEMBER

1 2 3 4 5 6 7 8 9 10 11 12 13 14 15 16 17 18 19 20 21 22 23 24 25 26 27 28 29 30 31

8



1993

S M T W T F S

JANUARY

						1	2
3	4	5	6	7	8	9	
10	11	12	13	14	15	16	
17	18	19	20	21	22	23	
24	25	26	27	28	29	30	
31							

FEBRUARY

	1	2	3	4	5	6	
7	8	9	10	11	12	13	
14	15	16	17	18	19	20	
21	22	23	24	25	26	27	
28							

MARCH

	1	2	3	4	5	6	
7	8	9	10	11	12	13	
14	15	16	17	18	19	20	
21	22	23	24	25	26	27	
28	29	30	31				

APRIL

				1	2	3	
4	5	6	7	8	9	10	
11	12	13	14	15	16	17	
18	19	20	21	22	23	24	
25	26	27	28	29	30		

MAY

						1	
2	3	4	5	6	7	8	
9	10	11	12	13	14	15	
16	17	18	19	20	21	22	
23	24	25	26	27	28	29	
30	31						

JUNE

		1	2	3	4	5	
6	7	8	9	10	11	12	
13	14	15	16	17	18	19	
20	21	22	23	24	25	26	
27	28	29	30				

JULY

				1	2	3	
4	5	6	7	8	9	10	
11	12	13	14	15	16	17	
18	19	20	21	22	23	24	
25	26	27	28	29	30	31	

AUGUST

1	2	3	4	5	6	7	
8	9	10	11	12	13	14	
15	16	17	18	19	20	21	
22	23	24	25	26	27	28	
29	30	31					

SEPTEMBER

		1	2	3	4		
5	6	7	8	9	10	11	
12	13	14	15	16	17	18	
19	20	21	22	23	24	25	
26	27	28	29	30			

OCTOBER

						1	2
3	4	5	6	7	8	9	
10	11	12	13	14	15	16	
17	18	19	20	21	22	23	
24	25	26	27	28	29	30	
31							

NOVEMBER

	1	2	3	4	5	6	
7	8	9	10	11	12	13	

