

NOVA

PAYLOADER

FLYING MODEL ROCKET

SKILL LEVEL 2

Recommended for the Experienced Modeler.

- Clear Payload Bay
- Great For Experimental Cargo
- 12" Parachute Recovery

Length: 21.125 in. (53.7 cm)

Dia: .976 in. (24.8 mm)

Weight: 1.33 oz. (37.5 g)

Recommended Engines:

A8-3 (First Flight), B4-4,

B6-4, B8-5, C6-5

This is a model kit requiring assembly. Glue and finishing supplies, launch system and engines for flight are not included.

**FLIES
TO
1000 FEET**



#1960



A DAMON COMPANY

ESTES INDUSTRIES
PENROSE, CO 81240 USA





A DAMON COMPANY

Estes Industries
1295 H Street
Penrose, CO 81240

NOVA PAYLOADER

#1960

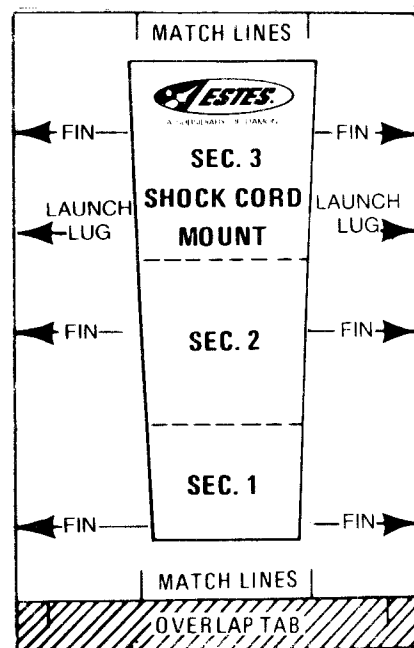

TUBE MARKING GUIDE

PARTS AND SUPPLIES

Locate the parts shown below and lay them out on the table in front of you. In addition to the parts included in the kit you will also need:

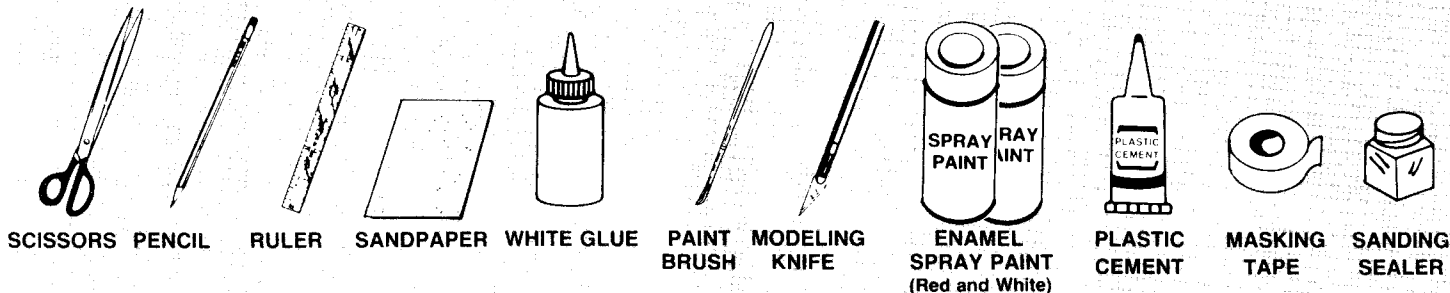

SCISSORS PENCIL RULER SANDPAPER WHITE GLUE PAINT BRUSH MODELING KNIFE ENAMEL SPRAY PAINT (Red and White) PLASTIC CEMENT MASKING TAPE SANDING SEALER

ASSEMBLY TIP

Read all instructions before beginning work on your model. Make sure you have all parts and supplies. Test-fit all parts together before applying any glue. If any parts don't fit properly, sand as required for precision assembly.

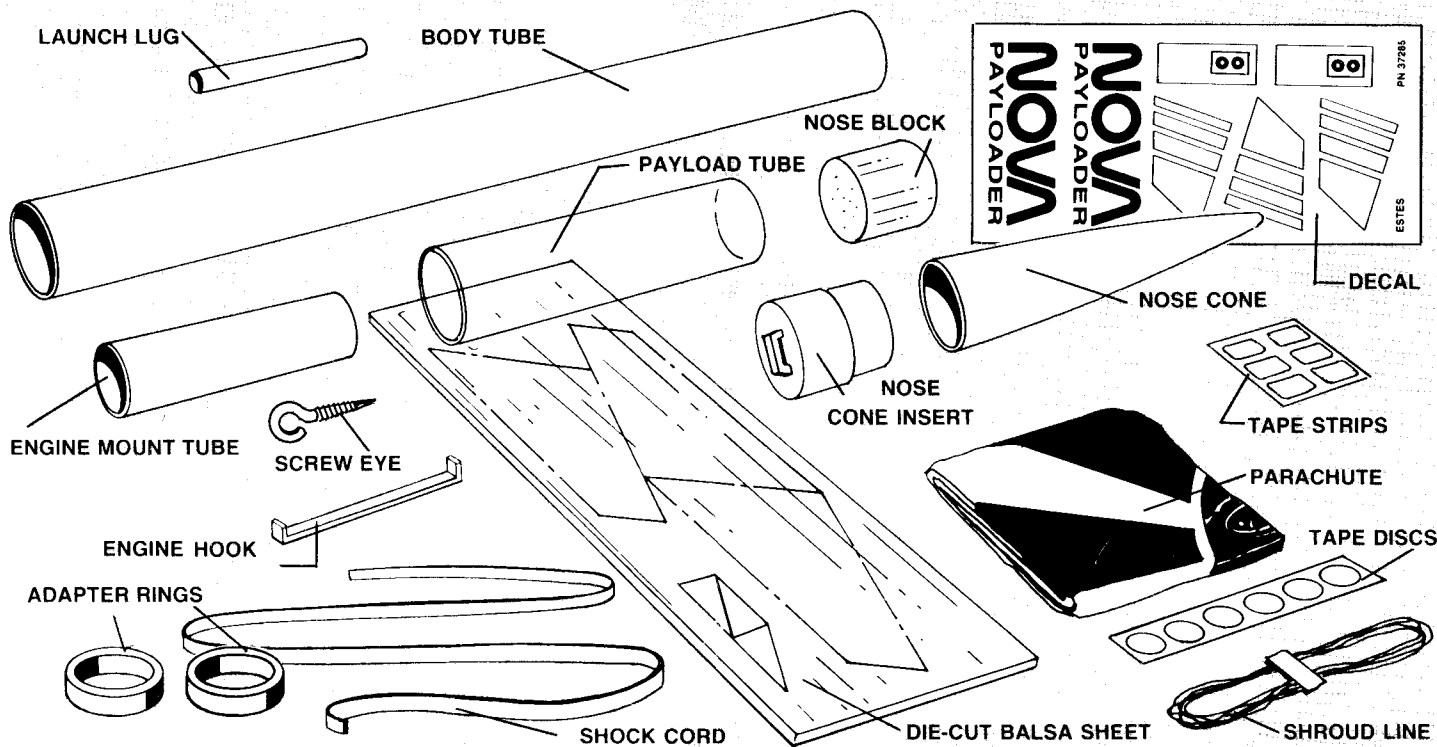

ROCKET ASSEMBLY

1.
 - A. Mark spacer tube 1 inch and 2½ inches from one end.
 - B. Cut 1/8 inch long slit at 2½ inch mark.
 - C. Insert one end of engine hook into slit.
 - D. Sand inside edges of both adapter rings.
 - E. Slide one ring onto front of tube and down to 1 inch mark. Glue both sides of ring/tube joint.
 - F. Apply glue around front of tube. Slide remaining ring into place.

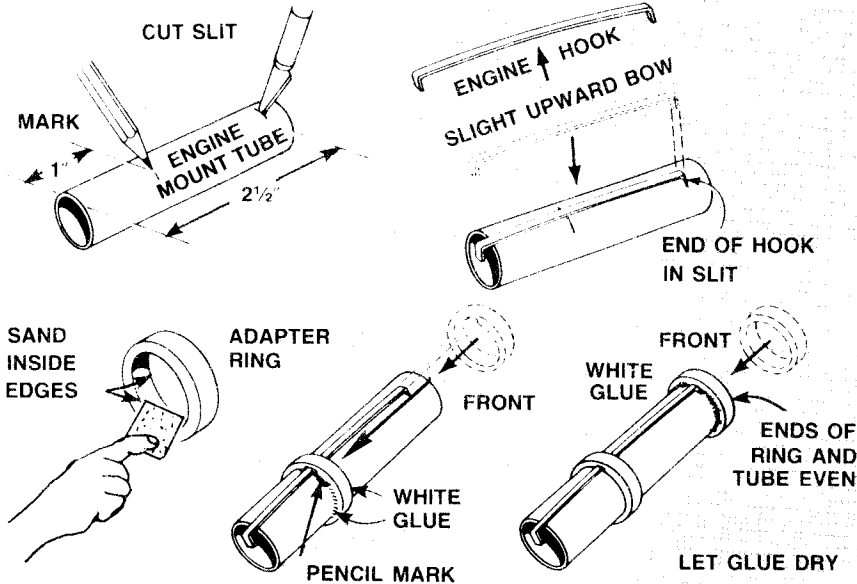

2.
 - A. Fine sand balsa die-cut sheet. Carefully remove fins by freeing edges with sharp knife.
 - B. Stack fins together. Sand all edges smooth.

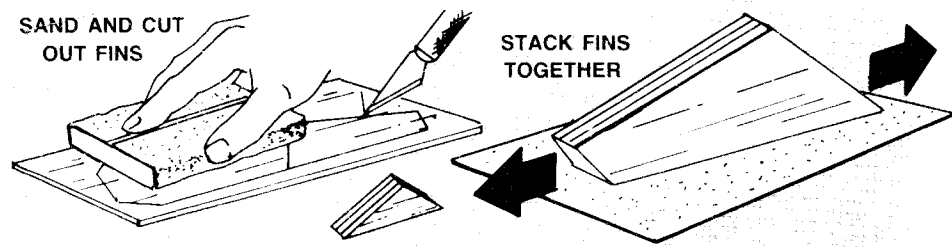

3.
 - A. Cover pattern sheet on back of panel with waxed paper and assemble fins.
 - B. Set each fin aside to dry after glue sets.

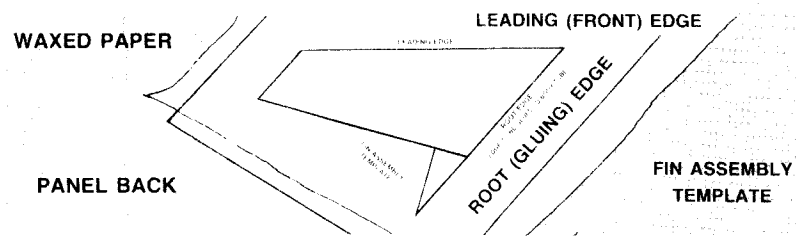

4.
 - A. Using a piece of scrap balsa, smear glue inside body tube 2 inches from one end.
 - B. Push engine mount in until tube ends are even. Engine hook must extend from end of body tube.

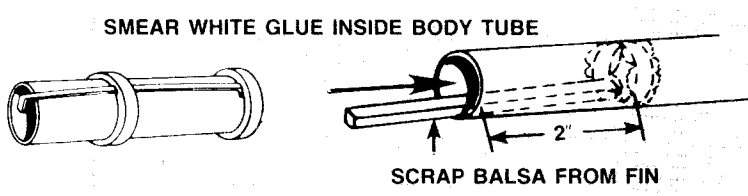

5.
 - A. Cut out tube marking guide from front of instructions.
 - B. Wrap guide around the tube and tape. Mark tube at arrows. Remove guide and save.
 - C. Draw straight lines connecting each pair of marks.
 - D. Extend launch lug line full length of tube.

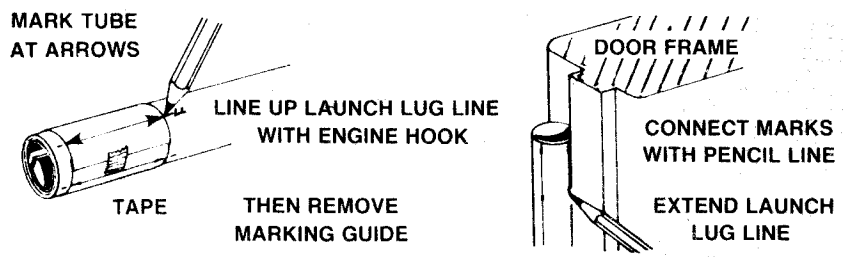

6.
 - A. Position and glue fins on alignment lines one at a time. Let each dry several minutes before applying the next one.
 - B. Adjust fins to project straight out from tube.
 - C. Do not set rocket on fins while glue is wet.

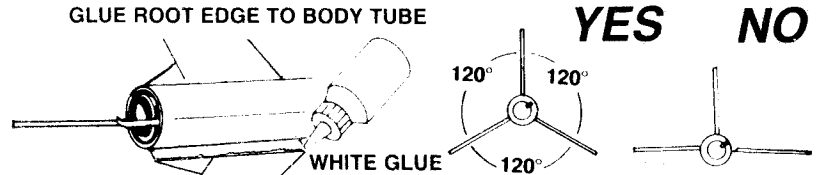

FINS MUST BE ATTACHED CORRECTLY FOR STABLE FLIGHT!

7.

Glue launch lug 3 1/4 inches from rear of rocket on its alignment line.

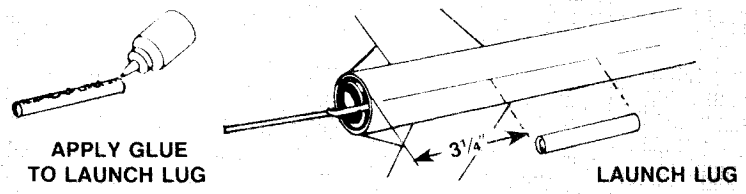

8.

- A. Cut shock cord mount from tube marking guide.
- B. Crease on dotted lines by folding. Spread glue on section 1 and lay end of shock cord into glue. Fold over and apply glue to back of first section and exposed part of section 2. Lay shock cord as shown and fold mount over again.
- C. Clamp unit together with fingers until glue sets.

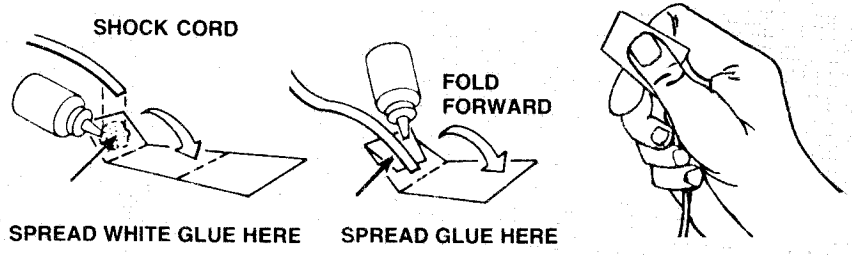

9.

- A. Apply glue to inside front of body tube to cover an area no less than 1 inch to 2 inches from end. The glued area should be same size as shock cord mount.
- B. Press mount as shown until glue dries.

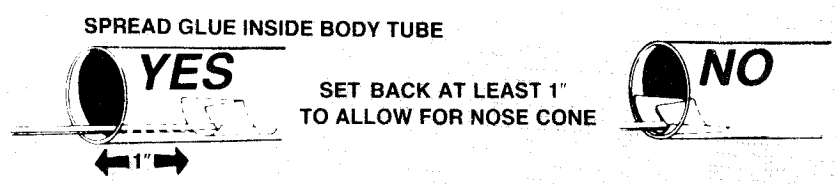

10.

- A. Apply a glue reinforcement to each fin/body tube joint and each side of launch lug.
- B. Support rocket as shown until glue dries.

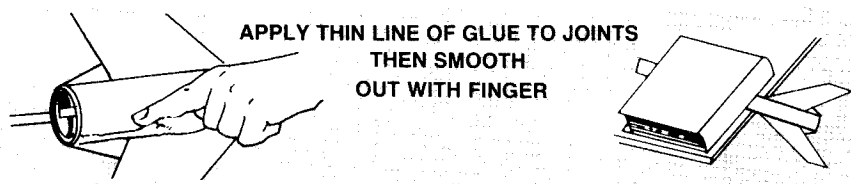

11.

- A. Apply 5 tape strips to inside of clear payload tube.
- B. Mark nose block at 1/2 inch from one end.
- C. Apply glue to nose block and push into clear payload tube up to mark.
- D. Insert screw eye into nose block.
- E. Remove screw eye, squirt glue into hole, and reinsert screw eye.

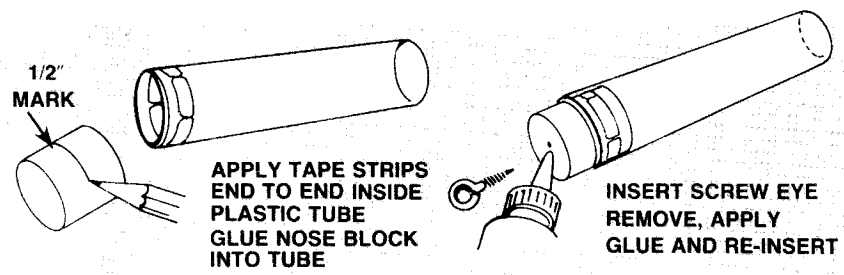

12.

- A. Cement nose cone and nose cone insert together with plastic model cement
- B. Push nose cone insert firmly into nose cone.
- C. After cement dries insert nose cone into payload section.

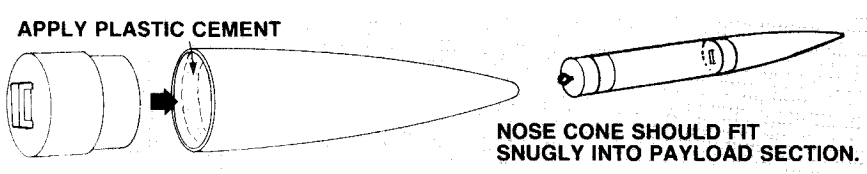

13.

- A. Cut out parachute on edge lines.
- B. Cut three 23 inch lengths of shroud line.
- C. Form small loops with shroud line ends and press onto sticky side of tape discs.
- D. Attach tape discs with line ends to top of parachute as shown.
- E. Firmly press tape discs into place until both tape discs and parachute material are molded around shroud line loops.
- F. Pass shroud line loops through screw eye on payload section. Pass parachute through loop ends and pull lines against the screw eye.
- G. Tie free end of shock cord to screw eye.

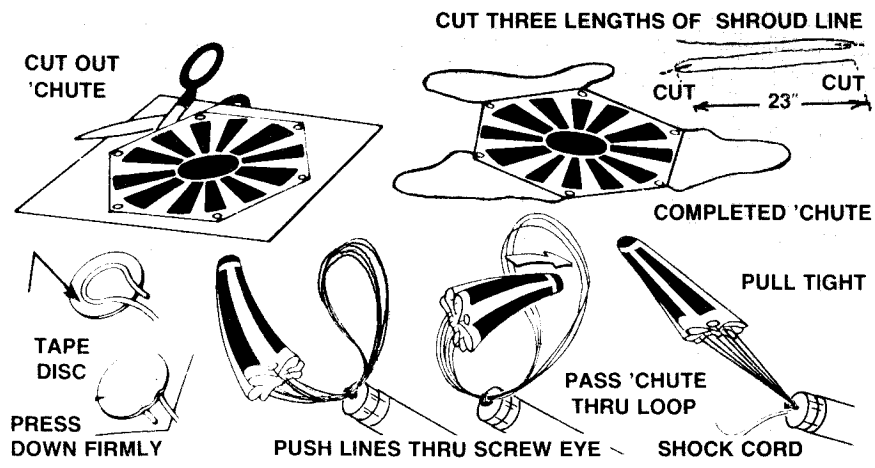

FINISHING YOUR ROCKET

Apply sanding sealer to wood parts with small brush. When sealer is dry, lightly sand all sealed surfaces. Repeat sealing and sanding until balsa grain is filled and smooth. When sanding sealer and glue are completely dry, paint fins and body tube with red spray enamel. Refer to panel photo for color locations. Paint nose cone and lower 5.8 inch

of payload tube with white spray enamel. Remainder of payload to stay clear. Refer to photo on front of instructions and photo on panel for decal placement. To apply decals, cut out each decal, dip in lukewarm water for 20 seconds, and hold until it uncurls. Slip decal off backing sheet and onto model. Blot away excess water.

ROCKET PREFLIGHT

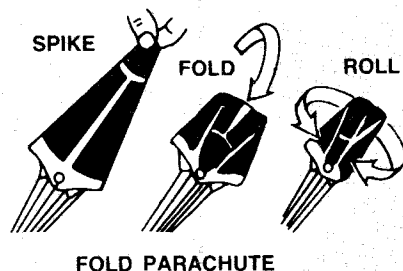
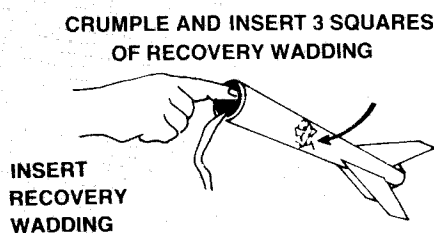

WRAP LINES LOOSELY AROUND CHUTE
INSERT PARACHUTE IN ROCKET

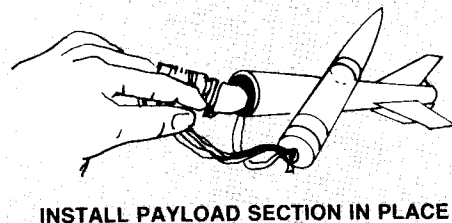

PREPARE ENGINE

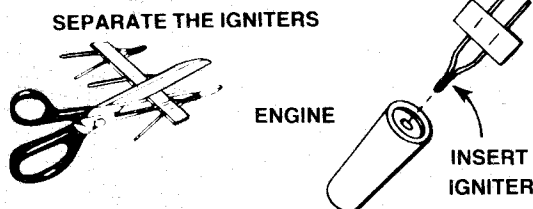

IGNITER TIP MUST TOUCH PROPELLANT DEEP INSIDE NOZZLE OPENING

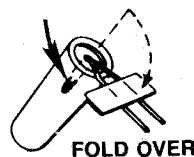

APPLY AND FIRMLY PRESS MASKING TAPE IN PLACE

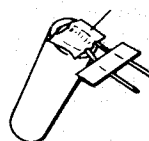

INSTALL ENGINE IN ROCKET

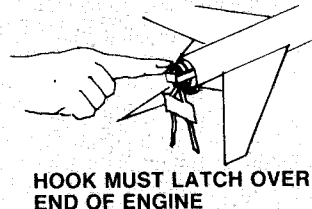

LAUNCH SUPPLIES

To launch your rocket you will need the following items:

- An Estes model rocket launching system
 - Estes Parachute recovery wadding (No. 2274)
 - Recommended Engines: A8-3, B4-4, B6-4, B8-5, C6-5
- Use A8-3 engine for your first flight to become familiar with your rocket's flight pattern.

FLYING YOUR ROCKET

Choose a large field away from power lines, tall trees, and low flying aircraft. Try to find a field at least 250 feet square. The larger the launch area, the better your chance of recovering your rocket. Football fields and playgrounds are great.

Launch area must be free of dry weeds and brown grass.

Launch only during calm weather with little or no wind and good visibility.

Don't leave parachute packed more than a minute or so before launch during cold weather [colder than 40° Fahrenheit (4° Celsius)]

MISFIRES

Failure of the rocket engine to function properly is nearly always caused by a failure to install the igniter correctly. This failure permits the igniter to heat and burn into two pieces without igniting the engine.

FOR YOUR SAFETY AND ENJOYMENT

Always follow the NAR-HIA* MODEL ROCKETRY SAFETY CODE while participating in any model rocketry activities.

*National Association of Rocketry—The Hobby Industry of America

COUNTDOWN AND LAUNCH

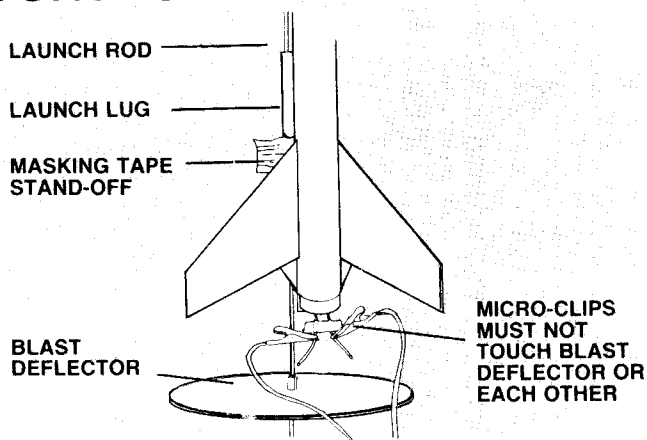

- 5 REMOVE SAFETY KEY to disarm the launch controller.
- 4 Remove safety cap and slide launch lugs over launch rod to place rocket on launch pad. Make sure the rocket slides freely on the launch rod.
- 3 Attach micro-clips to the igniter wires. Arrange the clips so they do not touch each other or the metal blast deflector. Attach clips as close to protective tape on igniter as possible.
- 2 Move back from your rocket as far as launch wire will permit. (at least 15 feet).
- 1 INSERT SAFETY KEY to arm the launch controller.

LAUNCH!!! PUSH AND HOLD LAUNCH BUTTON UNTIL ENGINE IGNITES

Remove safety key—Replace cap on rod.

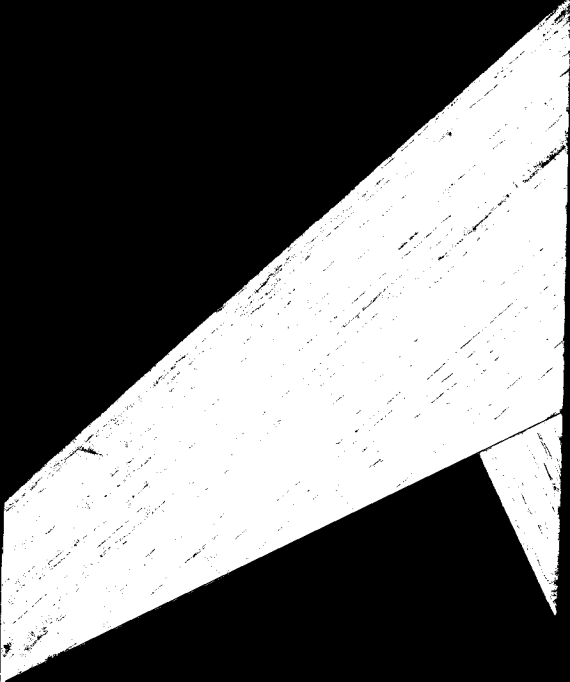

Nova Payloader
BFS-30 Stock

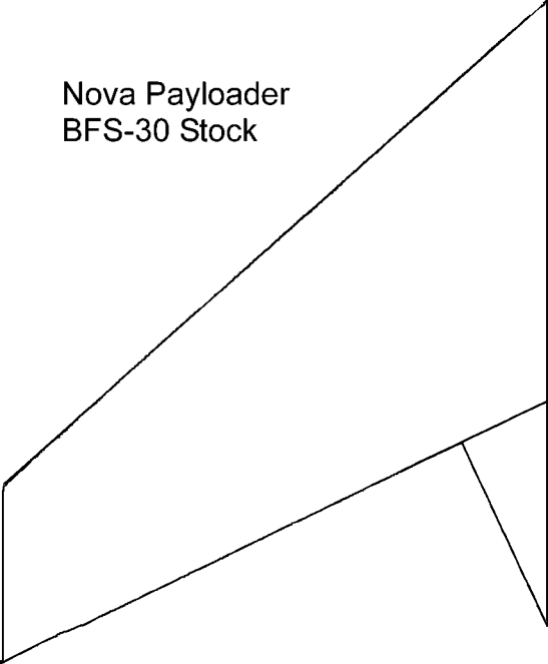

PN 37285

ESTES



NOVA
PAYLOADER

NOVA
PAYLOADER

Estes #1960 Nova Payloader Parts List

Nose Cone	PNC-50Y	4.1" (aprx)
Payload Body	PST-50S	4"
Main Body	BT-50L	12.7"
Bulkhead	NB-50	1"
Fin Stock	BFS-30	3/32" Thick Stock
Motor Tube	BT-20J	2.75"
Centering Rings	AR-2050 (2)	
Engine Hook	EH-2	
Launch Lug	LL-2B	2 3/8"
Screw Eye	SE-2	Medium
Parachute	PK-12	12"