

Stealth Interceptor^{T.M.}

I N S T R U C T I O N S

© 1993 Custom Rocket Company

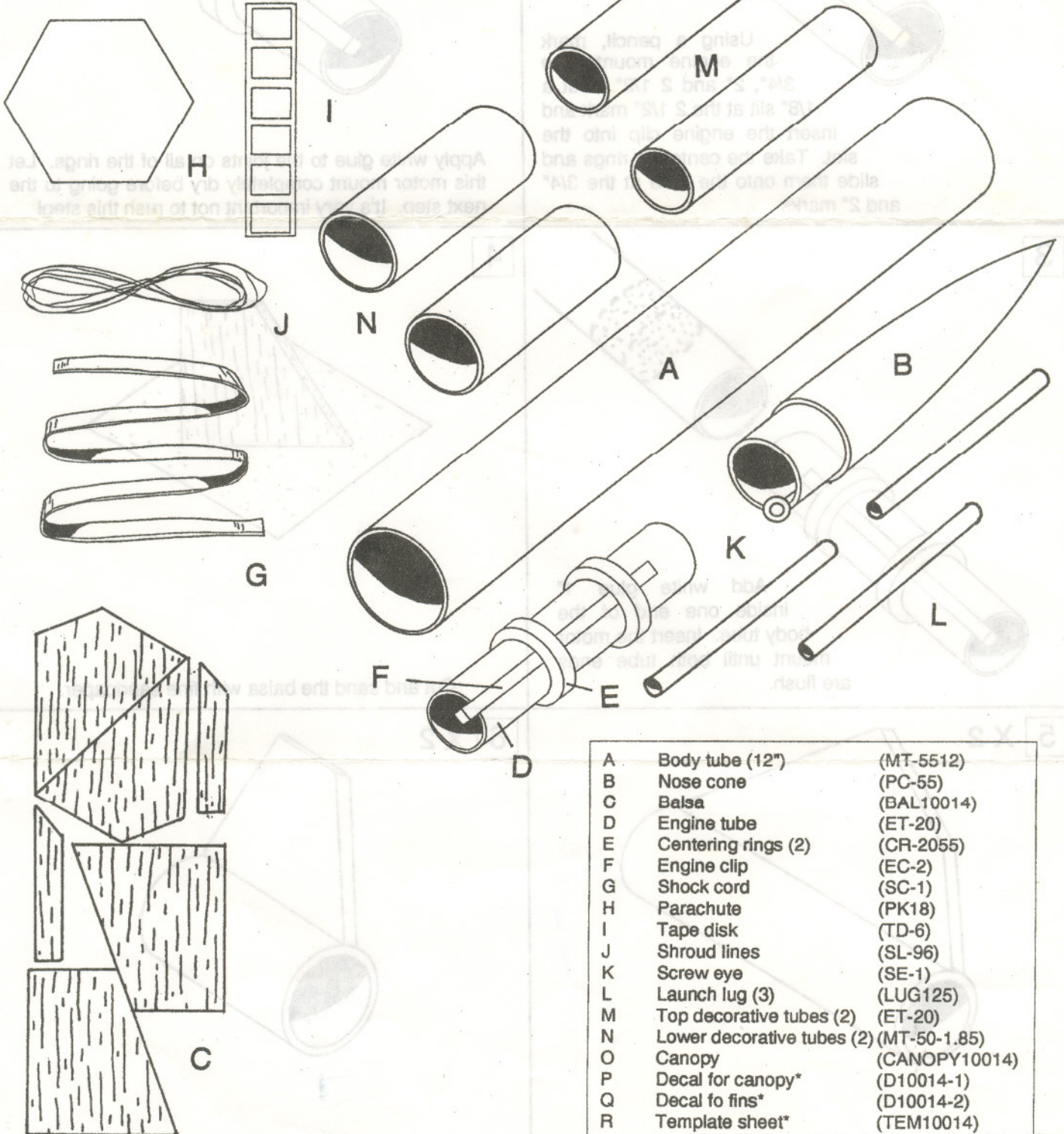
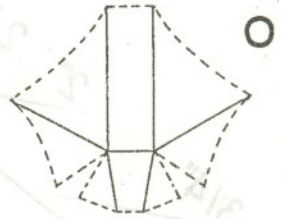

A	Body tube (12")	(MT-5512)
B	Nose cone	(PC-55)
C	Balsa	(BAL10014)
D	Engine tube	(ET-20)
E	Centering rings (2)	(CR-2055)
F	Engine clip	(EC-2)
G	Shock cord	(SC-1)
H	Parachute	(PK18)
I	Tape disk	(TD-6)
J	Shroud lines	(SL-96)
K	Screw eye	(SE-1)
L	Launch lug (3)	(LUG125)
M	Top decorative tubes (2)	(ET-20)
N	Lower decorative tubes (2)	(MT-50-1.85)
O	Canopy	(CANOPY10014)
P	Decal for canopy*	(D10014-1)
Q	Decal for fins*	(D10014-2)
R	Template sheet*	(TEM10014)
	*Items not shown	

Give the fin to the 1.85" long tube. Do this step twice.

Give the fin to the 3/4" long tube. Do this step twice.

1

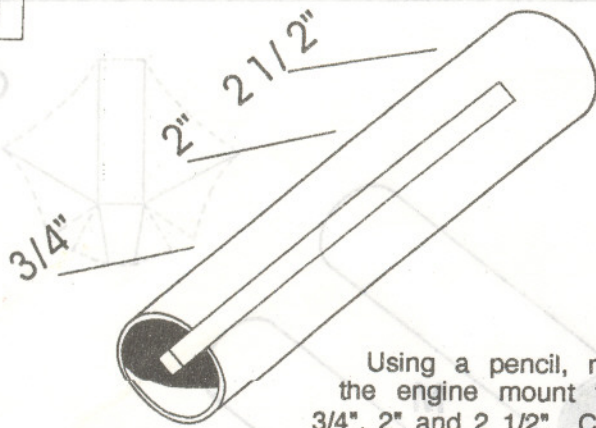

Using a pencil, mark the engine mount tube $3/4"$, $2"$ and $2\ 1/2"$. Cut a $1/8"$ slit at the $2\ 1/2"$ mark and insert the engine clip into the slot. Take the centering rings and slide them onto the tube at the $3/4"$ and $2"$ marks.

2

GLUE

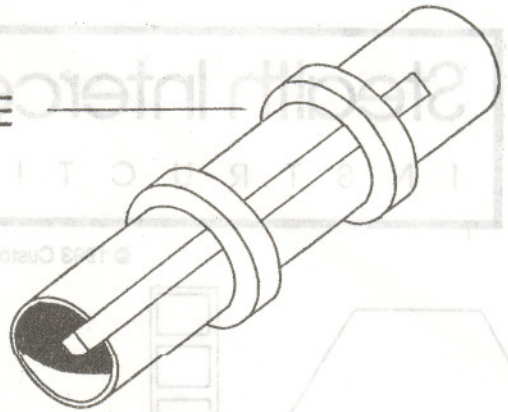

Apply white glue to the joints on all of the rings. Let this motor mount completely dry before going to the next step. It's very important not to rush this step!

3

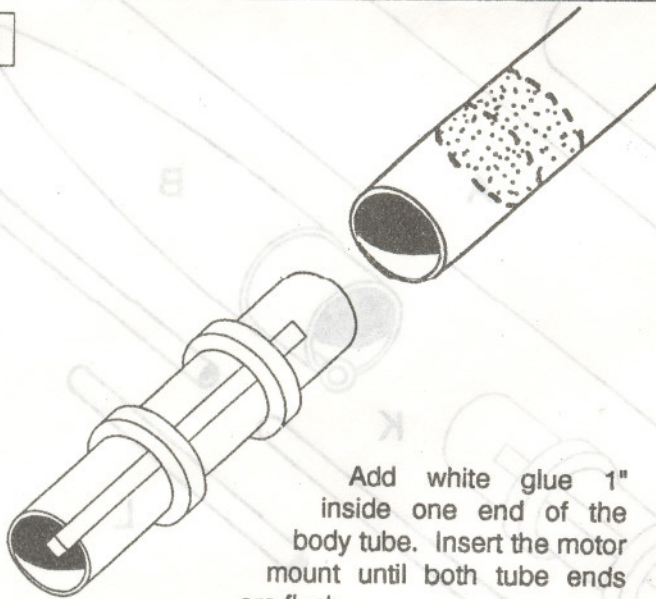

Add white glue $1"$ inside one end of the body tube. Insert the motor mount until both tube ends are flush.

4

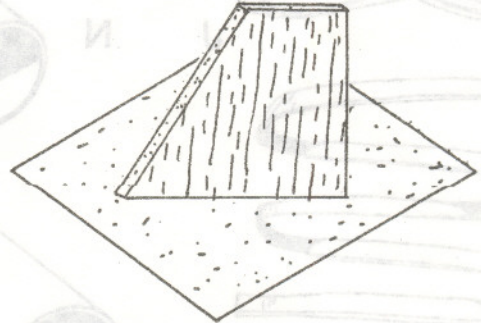

Cut and sand the balsa with fine sandpaper.

5 X 2

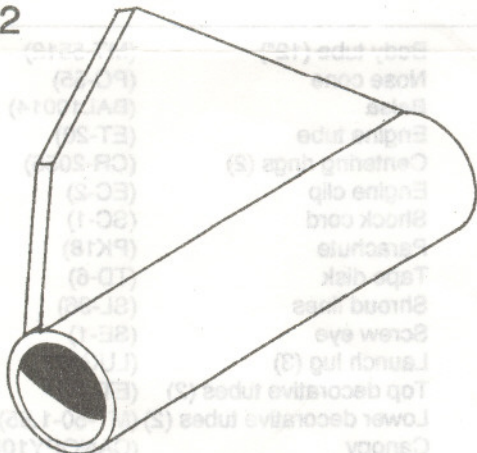

Glue the fin to the $2\ 3/4"$ long tube. Do this step for both $2\ 3/4"$ tubes twice.

6 X 2

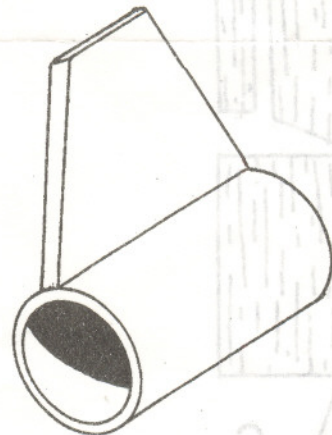

Glue the fin to the $1.85"$ long tube. Do this step twice.

7 X 2

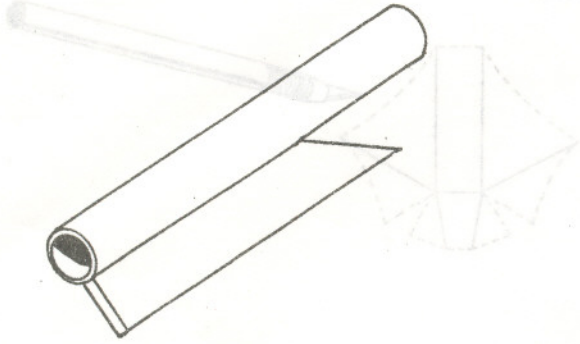

Glue the launch lug to the remaining balsa support. Do this step twice. These are the laser cannons.

8

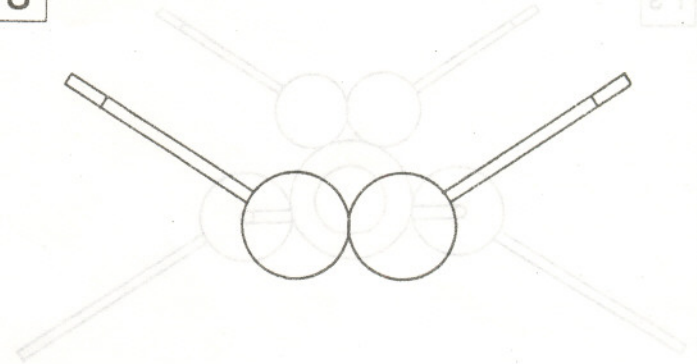

Take the two fins units, which were glued in step 5, and place them onto the template guide. Glue the two together as shown.

9

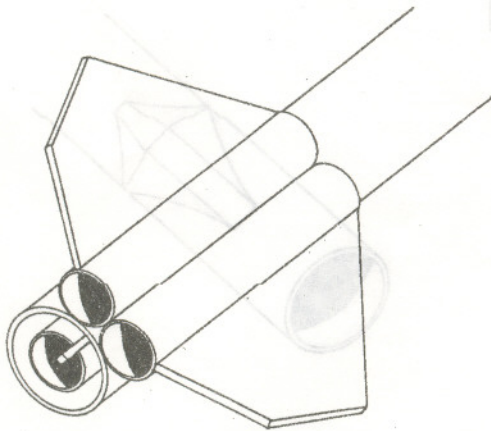

Take the fin unit, which was glued in step 8, and glue to the body tube as shown above.

10

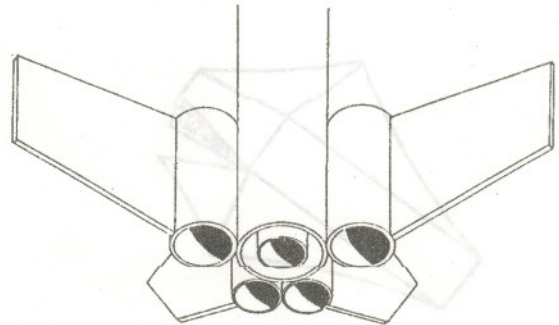

Place the model on the fin template sheet again, and glue the bottom fin unit onto the tube. The body tube and the two fin units should be even.

11

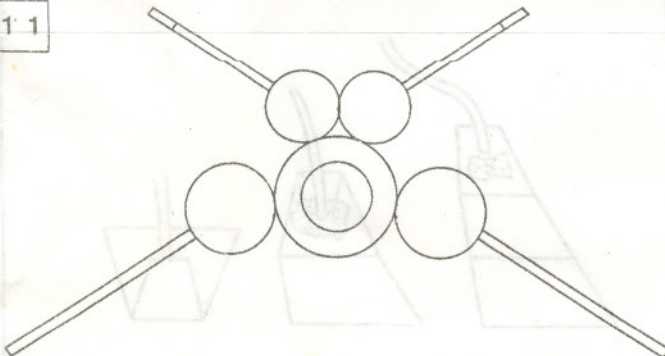

This is how the end view should look.

12

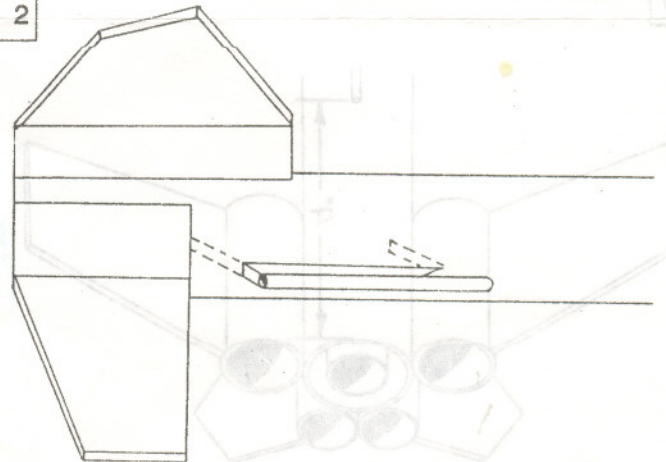

Glue the laser cannons to the body tube. The balsa supports should be just in front of the short tube, but not inside.

13

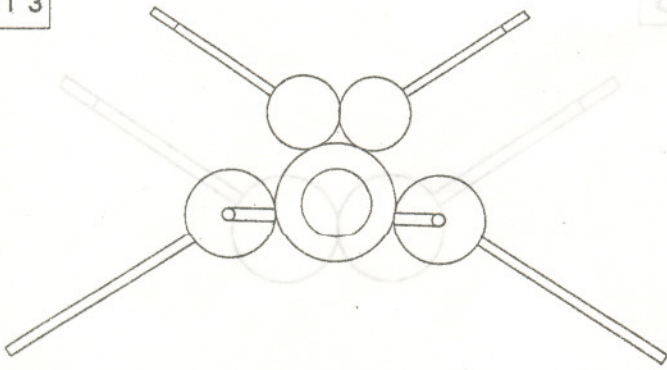

This is an end view for the location of the laser cannons.

14

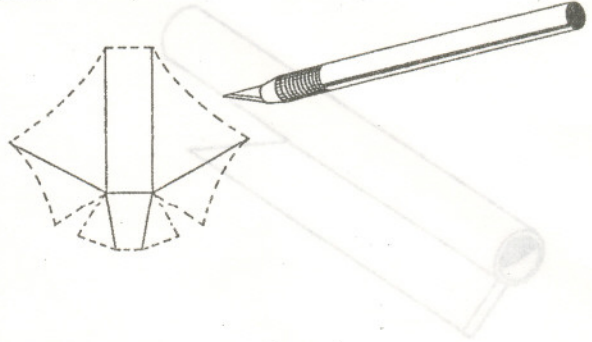

Cut the canopy on the dotted line.

15

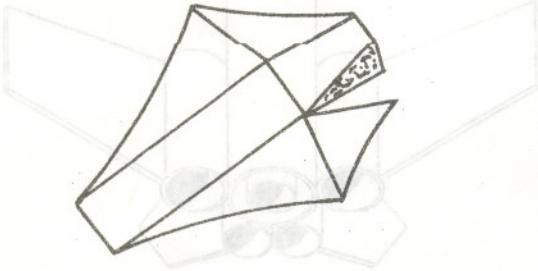

Fold the canopy on the solid lines. Apply glue to the two tabs and glue canopy together.

16

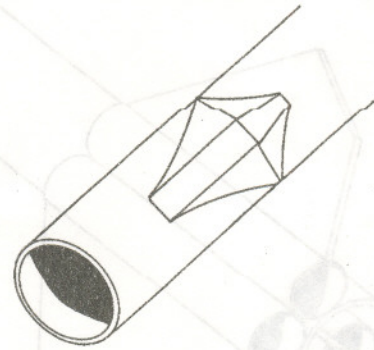

Apply a thin line of glue inside the canopy and glue $\frac{3}{4}$ " from the end of the body tube.

17

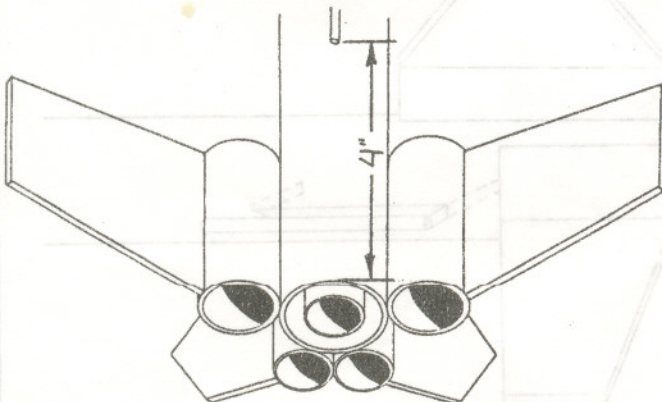

Glue the launch lug 4" from the end of the body tube.

18

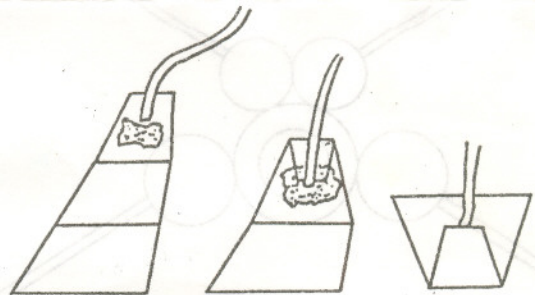

- A. Cut out the shock cord mount and apply glue to section 1. Lay the end of the shock cord into the glue.
- B. Fold section 1 at the fold line and squeeze with your fingers.
- C. Apply glue to the back of section 1 and fold to section 3. Put complete assembly under a heavy object.

19

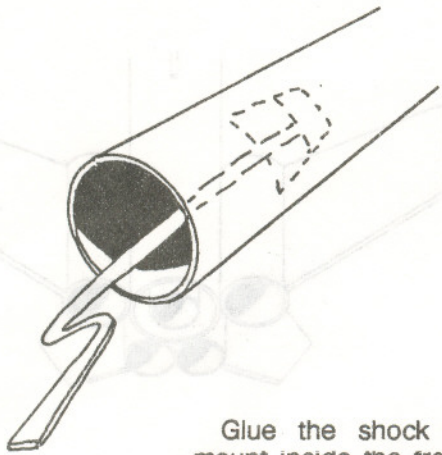

Glue the shock cord mount inside the front of the body tube 1" from the end. Hold the mount until it dries.

20

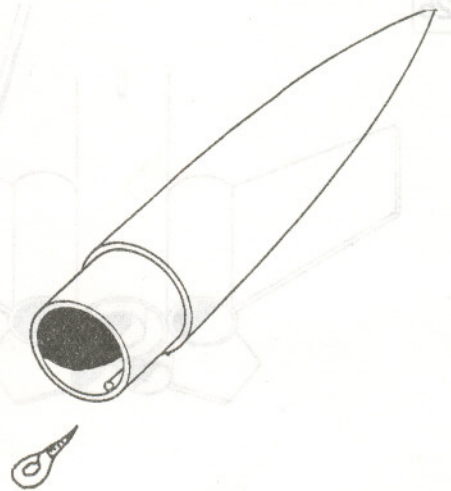

Screw the screw eye into the nose cone.

21

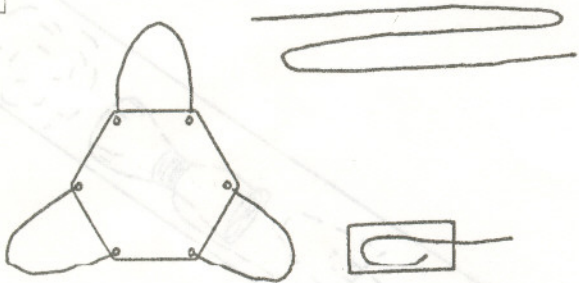

- A Cut the shroud line into three equal parts.
- B Attach the end of the shrouds to the tape disks.
- C Tape the disks to the parachute as shown.

22

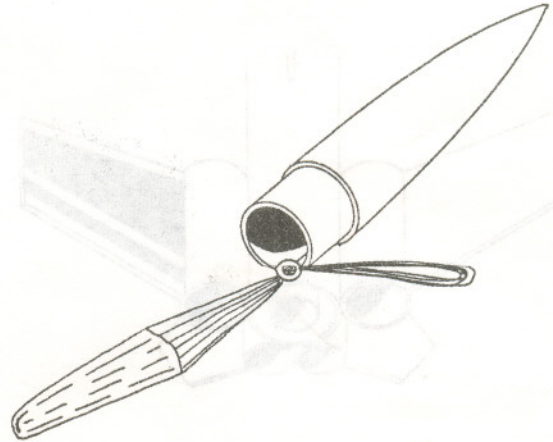

Thread the shroud line loops through the screw eye.

23

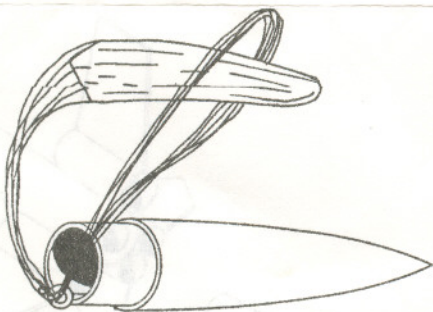

Take the loop ends and pass the parachute through.
Pull the parachute tight.

24

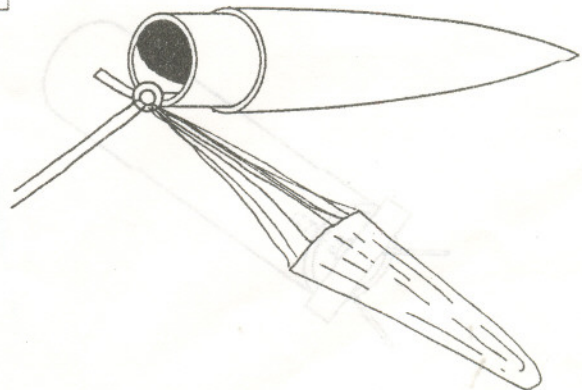

Tie the end of the shock cord to the screw eye.

25

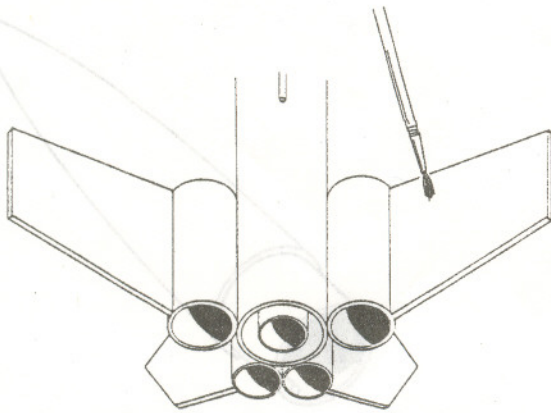

Apply sanding sealer to all the fins and sand with fine sandpaper. Repeat until all the grain is filled.

26

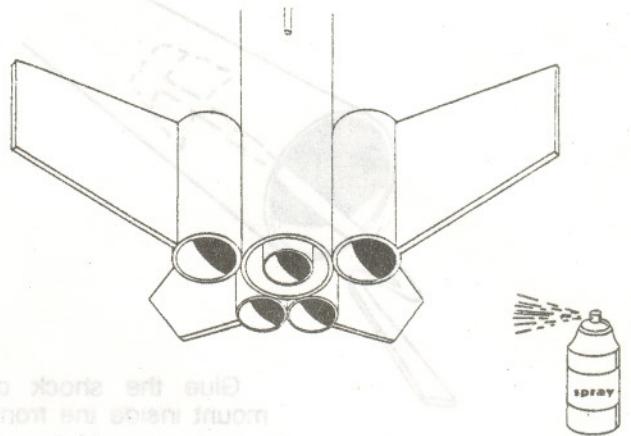

Spray the model with gold spray paint.

27

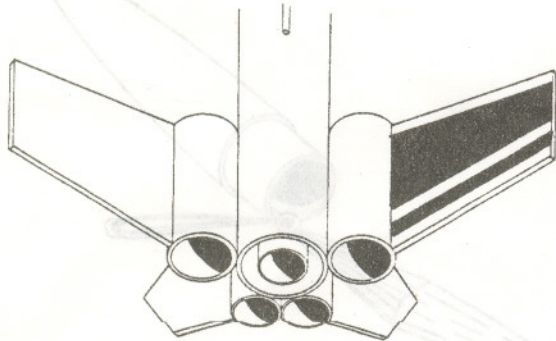

Dip the decals in water for 30 seconds and slide them onto the model.

28

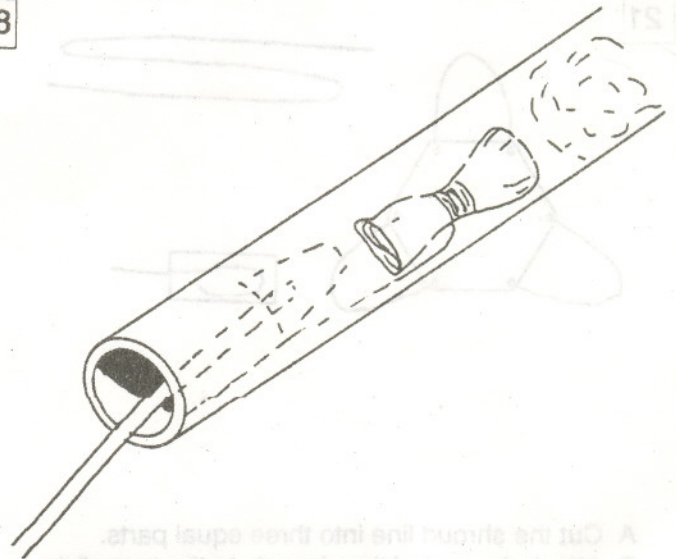

Insert parachute wadding into the rocket. Fold the parachute and insert into the rocket.

29

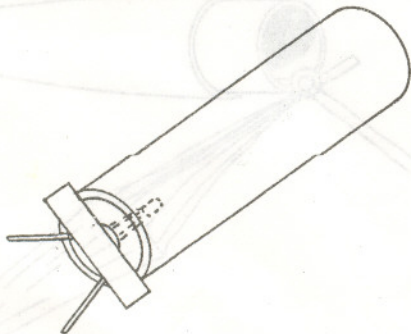

Insert the igniter into the recommended engine (recommended engines are shown in the catalog, or on the packaging). Tape or use an igniter plug to keep the igniter in the engine.

30

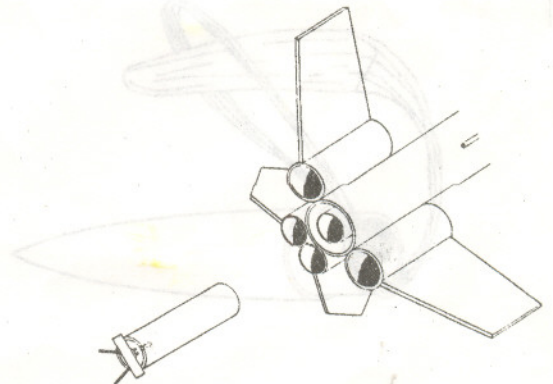

Insert the engine into the rocket. Slide the launch lug over the launch pad and hook up the igniter clips to the igniter. Do not put engines into any of the exterior tubes. This model is designed to fly with one engine inserted in the engine mount.

Stealth Interceptor Template

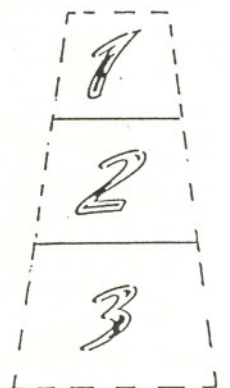
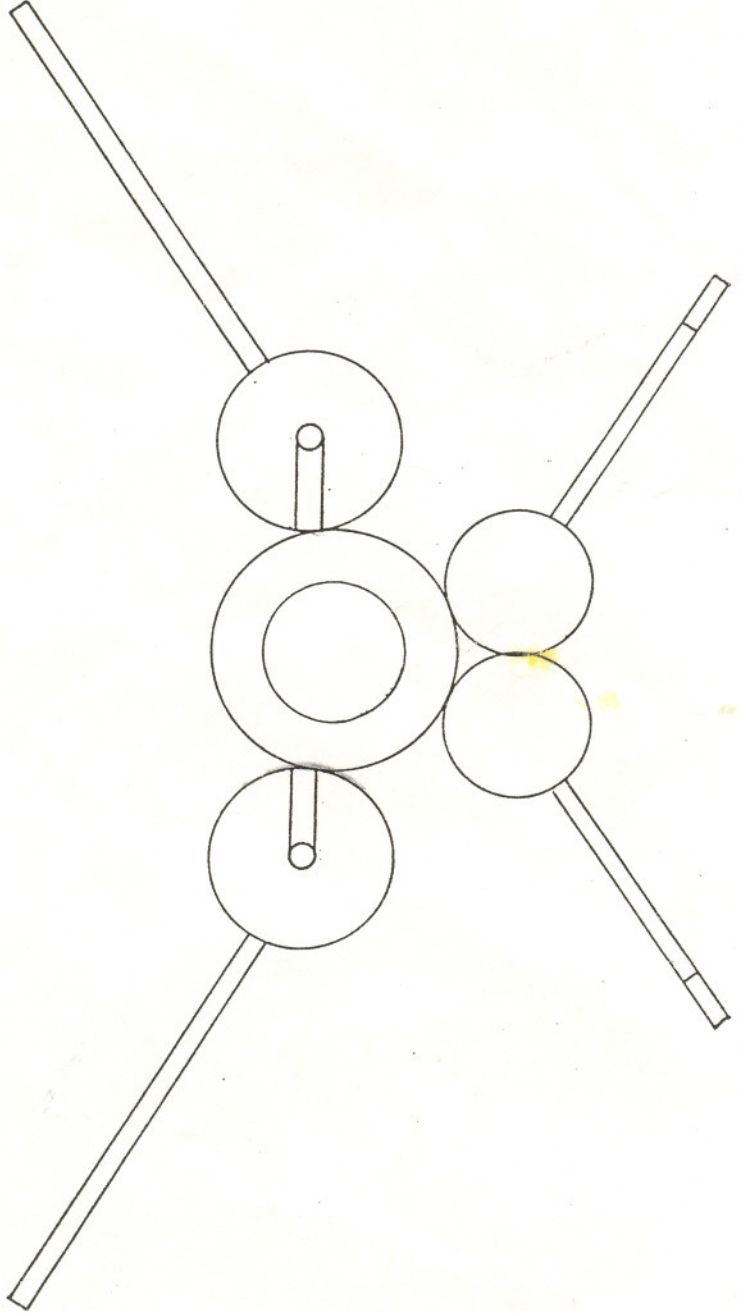

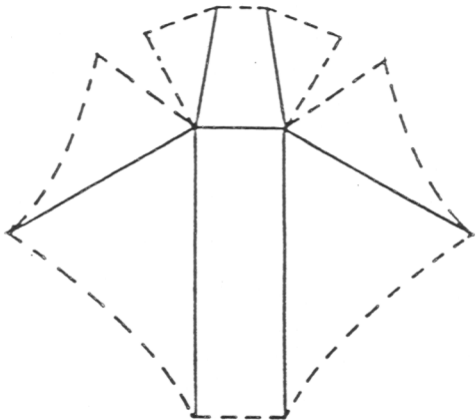

TODAY

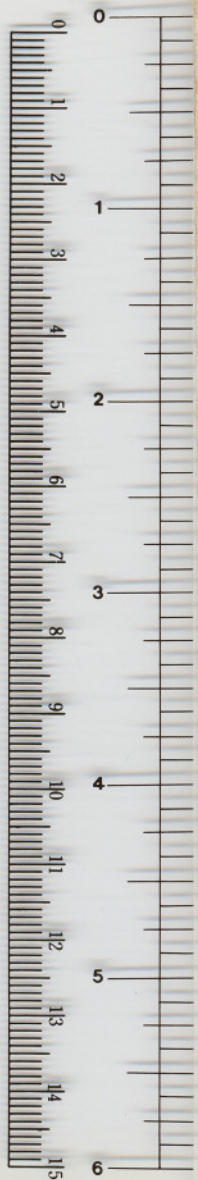

Quick Page Finder



TODAY

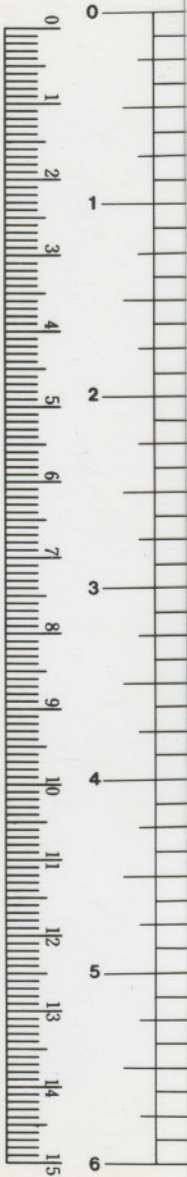

Quick Page Finder

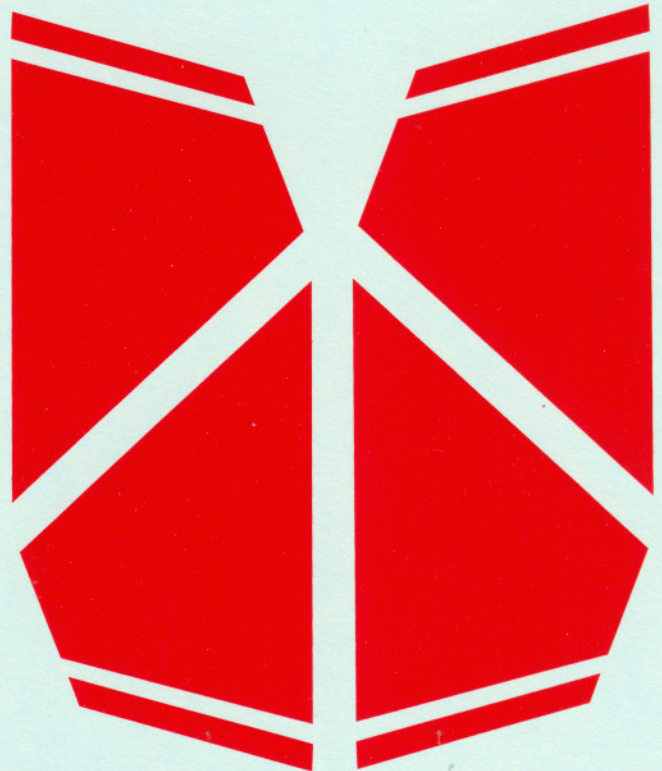
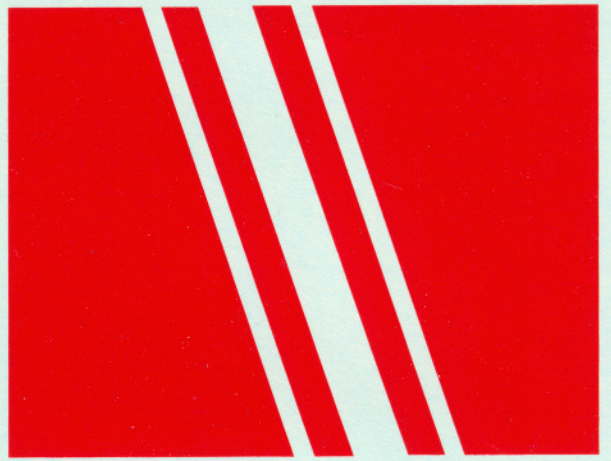
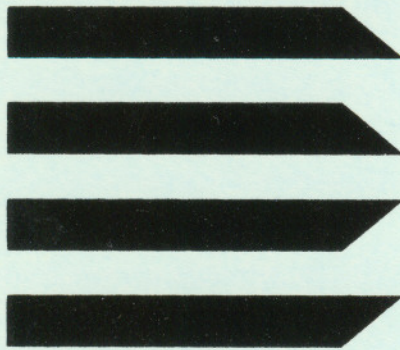
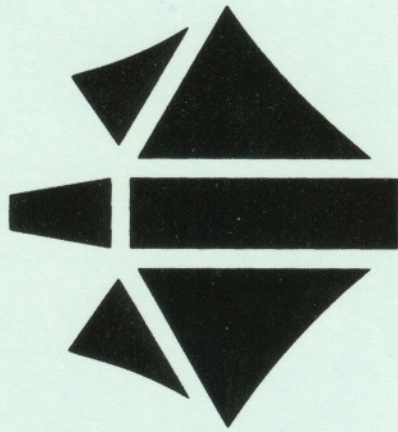

Stealth Interceptor

T.M.

Flying Model Rocket

3
Skill Level

- Fighter of the 25th century
- Canopy
- Plastic nose cone

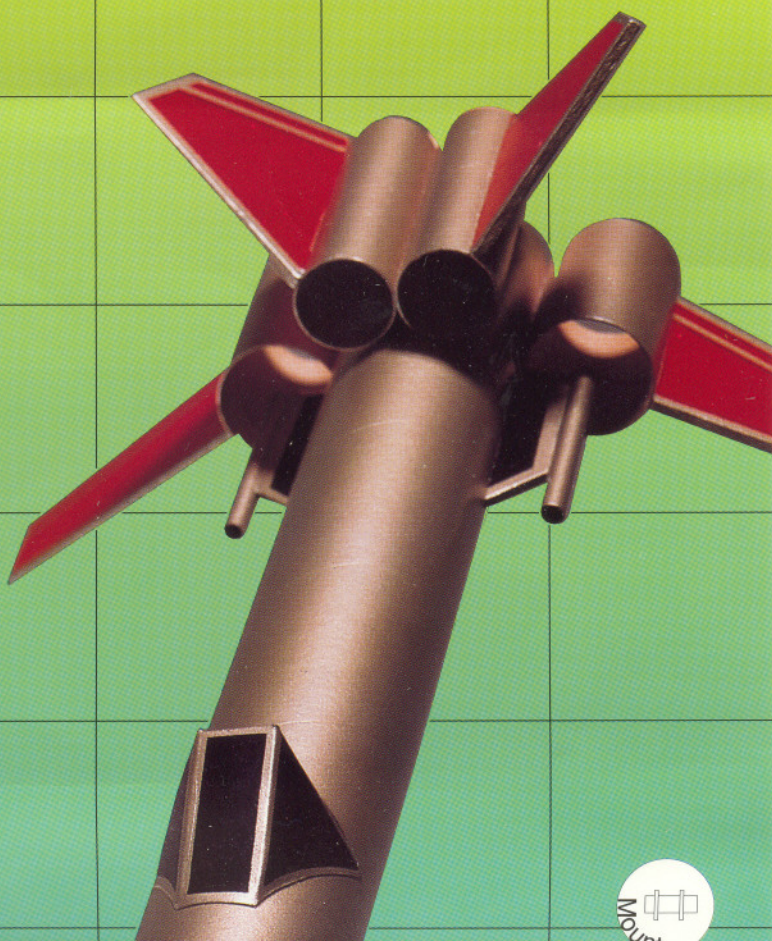

•Fighter of the
25th century

•Canopy

•Plastic nose cone

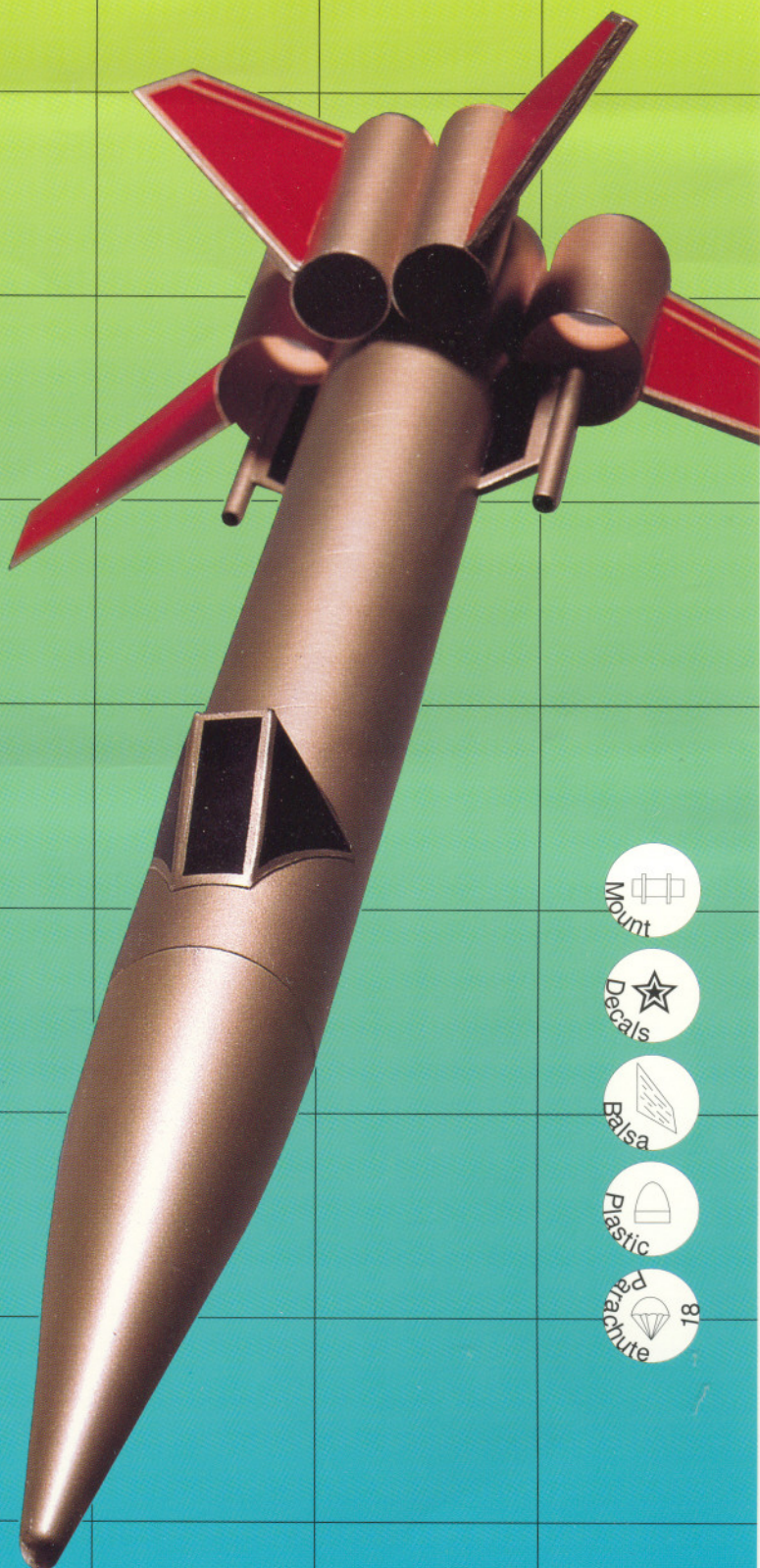

18



Length 17.5" (44.5cm)
Dia.: 1.325" (33.7mm)
Wt.: 1.6 (44g)
Engines: B4-2, B4-4, B6-2,
B6-4, B8-5, C5-3, C6-5



 T.M.

Product No. 10014